



Quasar Management Services Pty Limited
ABN 21 003 954 210 Member of Consult Australia
Not-for-profit consulting structural and civil engineer
69 Renwick Street, Redfern NSW 2016, Australia
Phone: +61 432 611 550
Email: RodJohnstonAUS@gmail.com

Two Classrooms and Office

GENERIC DESIGN for the Highlands & Non-cyclonic Regions of PNG

This document has been prepared on behalf of Partner Housing Australasia,
for construction performed by Vision for Homes (PNG) in the designated areas.



Partner Housing Australasia (Building) Incorporated
ABN 88 722 057 429 CFN: 15429
Web: www.partnerhousing.org
Pro-bono professional services and funding for South Pacific
village infrastructure, housing, water, sanitation and training.
69 Renwick Street, Redfern NSW 2016, Australia
Phone: +61 432 611 550
Email: partner.housingaus@gmail.com



Vision for Homes Papua New Guinea Inc.
P.O Box 635 Mt. Hagen, 281
Western Highlands Province
Papua New Guinea
Phone: (675) 7358 1231 /7608 3862
Email: visionforhomespng@gmail.com
www.visionforhomespng.com

Contents

Limited Structural Certification.....	4
Planning and Architectural Design	6
Description.....	6
General Arrangement.....	7
Floor Plan of Left-Hand Class Room, Office and Veranda	8
Floor Plan of Right-Hand Class Room, Office & Veranda	9
Elevations	10
Sections.....	12
Electrical Services	14
Plumbing.....	16
Roof Plumbing	17
Engineering Design	19
Dancer Building System	19
Gridlines.....	20
Subfloor Pier, Post and Bracing Arrangement.....	21
Bearer & Joist Arrangement	22
Roof Truss, Purlin & Bracing Arrangement.....	24
Details of DANCER Trusses	26
DANCER Truss Bolted Apex Splice	27
DANCER Truss Bolted Bottom Chord Splice	29
Purlin, Diagonal Lacing and Double Top Chord Connections	30
Double Bottom Chord, Anchorage Stud and Eaves Connections	31
Roof Fixings and Cyclone Washers	32
End Wall Framing.....	33
Front Wall Framing.....	35
Rear Wall Framing	36
External Wall Frame Details	37
Bearers, Joists, Floor, Posts and Stud Arrangement.....	41
Diagonal Sub-floor Bracing and Steel Posts.....	43
Concrete Piers and Steel Posts	44
Plan of Corner Showing Bearer, Joist, Post and Studs.....	45
Gridlines and Steel Post orientation.....	45
Stairs	47
Stair Balustrades.....	48

Veranda Balustrades.....	49
Window Shades.....	50
Concrete Mix for Piers and Footings.....	51
Details requiring special monitoring.....	52
Cutting Lists.....	54
Jig for Fabricating DANCER 8.4 Trusses.....	56
Specifications.....	58
Timber.....	58
Scope.....	58
Relevant Standards.....	58
Levels, Dimensions, Square and Setting Out.....	58
Bracing.....	58
Tie Down.....	58
Timber Shrinkage.....	58
Preservatives.....	59
Design and Construction.....	60
Minimum Strength Grade.....	60
Timber Type, Properties, Preservation and Application.....	60
Timber and Timber Products for Use Below Found Level.....	60
Concrete.....	61
Scope.....	61
Building Regulations and Standards.....	61
Relevant Standards.....	61
Definitions.....	61
Reinforcement.....	61
Placing Concrete.....	61
Bill of Quantities.....	62
Calculations.....	78

Revisions

This document, and its component parts, constitute a working file, which is updated progressively and periodically formalised as work is undertaken. The revision dates represent when the consolidated information herein was activated.

Q25120101-1 1 December 2025 Routine update

Limited Structural Certification



Quasar Management Services Pty Limited
ABN 21 003 954 210 Member of Consult Australia
Not-for-profit consulting structural and civil engineer
69 Renwick Street, Redfern NSW 2016, Australia
Phone: +61 432 611 550
Email: RodJohnstonAUS@gmail.com

1. The purpose and intention of this document are to describe, in **generic** terms, the design and detailing of the DANCER Building System for **a double classroom building (including an office)**. It is consistent with previous requirements for similar buildings in the PNG Highlands.
2. These designs are suitable for adaption for specific sites in the Papua New Guinea (PNG) Highlands and other non-cyclonic regions of PNG.
3. Adaptation of these generic designs for specific sites must be performed by a suitably qualified and experienced structural engineer, with the authority and responsibility to monitor and certify the design and construction.
4. Quasar Management Services, its employees, contractors and sub-consultants do not accept any responsibility for the execution, monitoring or certification of the adaptation process specified herein.
5. This certification is applicable only to the designs described herein, including the stated external dimensions, member sizes, materials, connection details, fixings and internal layout. Any deviation in any way from the designs and specifications herein renders this certification invalid for the particular project.
6. This certification is applicable only to the construction by builders (e.g. Vision for Homes [PNG]) that have been approved and trained by Quasar Management Services. This certification is rendered invalid for construction by all other builders or contractors.
7. The designs herein may not be used for applications that do not comply with the building, locations and designs listed below.

Location: Papua New Guinea Generic

Building: Small detached village building; Presenting a low degree of hazard to life and other property in case of failure;

Single storey; Cladding on elevated braced timber frame complying with the DANCER design principles;

Maximum dimensions: 16.5 x 8.4 m, 2.7 m storey, Maximum eaves height 6.0 m, Maximum ridge height 8.5 m, Maximum pitch 35°

Design: Design life 25 years; Annual probability of exceedance 1 in 250; Probability of exceedance during design life: 0.10

Soil: Based on a rectangular footing 450 mm wide founded 600 mm deep in compacted soil.

Soil Type	AS 2870 Site Classification	Characteristic internal friction angle, degrees	Characteristic cohesion, kPa	Characteristic ultimate bearing capacity, kPa
Sand or rock	A	36°	0 kPa	1060 kPa
Slightly reactive clay	S	30°	3 kPa	670 kPa
Moderately reactive clay	M	27°	6 kPa	640 kPa

Permanent Loads: Elevated timber building, $w = 2.5 \text{ kN/m}^2$ (floor area), Reinforced masonry building $w = 3.5 \text{ kN/m}^2$ (floor area)

Imposed Loads: Floor load 1.5 kPa; Roof load 0.25 kPa

Wind: Most of the country except south-east. (refer also to map for reduced velocities)

Noncyclonic Level I $V_{u\ 500\ (3,10)} = 40 \text{ m/s}$ $k_{p\ 500} = 1.0, k_{p\ 250} = 0.90$

Resulting in wind Classification of N2 or N1 (to AS 4055)

Earthquake: Probability $k_{p\ 500} = 1.0, k_{p\ 250} = 0.75$; Hazard $Z_{500} = \text{As per table below}$; Subsoil = C; Ordinate $C_{h(T1)} = 3.68$; Ductility, $\mu = 2.00$; Performance, $S_p = 0.77$

Location	Hazard Z_{500}
Zone 3 (Moderate Hazard) – Central region of the mainland, Northern Province, D'Entrecasteaux and Trobriand Islands, Northern New Ireland and Admiralty Islands (Includes Mendi, Kerema, Klunga, Wabag, Mt Hagen, Kundiawa, Goroko, Bulolo, Wau, Popondetta, Lombrum, Lorengau, Kayieng)	0.24
Zone 4 (Very Low Hazard) – Papuan Peninsula - Louisiade Archipelago and St. Mathias Group (Includes Daru, Port Moresby, Alotau)	0.16

Tsunami: Not applicable. For each site, determine that the combination of distance from high water mark, height of finished floor above mean sea level, distance from high earthquake area ($Z > 0.4$), are such that the Tsunami Risk Factor is zero.

Flood: Not applicable. For each site, determine that the distance to closest water course OR height of finished floor above normal level of water course OR funnelling of catchment runoff past structure are such that the Flooding Risk Factor is 0.

Subject to the conditions above, I certify that the generic building described in this document complies with: principles of structural mechanics for strength, stability and serviceability; and the specific requirements of the relevant Australian Standards.

Buildings outside the scope described above must be designed for the relevant applicable local wind classifications and other relevant factors, using the principles described herein, by a suitably qualified and experienced structural engineer.

This is not a Construction Certificate.



Rod Johnston

B Tech, M Eng Sc, MICD, MIE Aust, Life-Member Consult Australia

Managing Director – Quasar Management Services Pty Ltd

Planning and Architectural Design

Description

The standard “Two Classrooms and Office” buildings consists of –

Two standard DANCER 6.6 x 8.4 “Single Classrooms”, each with 4 No 1200 x 800 louvre windows, 1 No 2040 x 820 external door and 1 No 2040 x 820 internal door. The left-hand classroom is “as drawn”, and the right-hand classroom is built “opposite hand”.

There is a 3.3 metre space between the external walls of the two classrooms. $6.6 + 3.3 + 6.6 = 16.5$ overall.

This 3.3 m space is filled by the Office, with 3 No 1200 x 800 louvre windows, 1 No 2040 x 820 external door and 2 No 2040 x 820 internal doors (to the classrooms), the Veranda and the double-width Steps.

This building has been designed to meet the dual criteria of cultural sensitivity and structural resistance to non-cyclonic wind and moderate earthquake.

General Arrangement

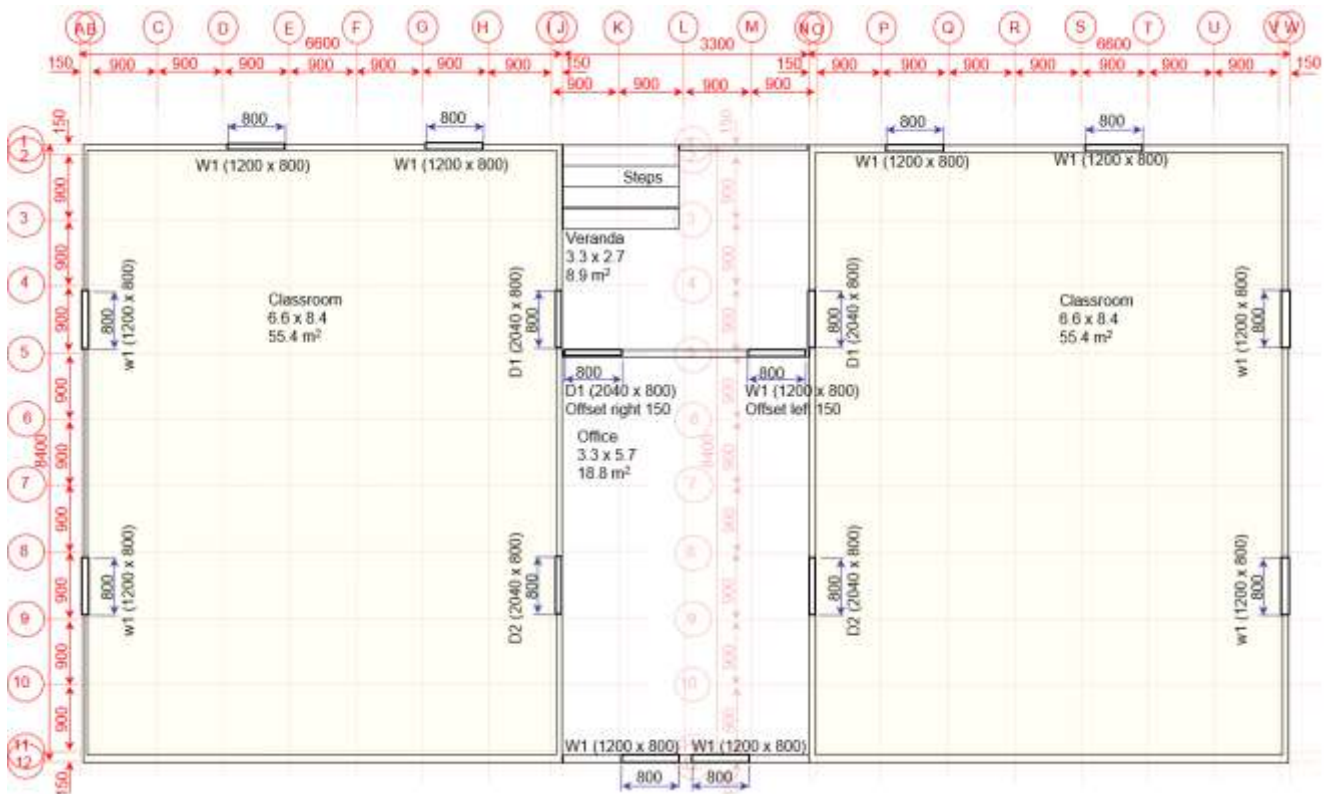
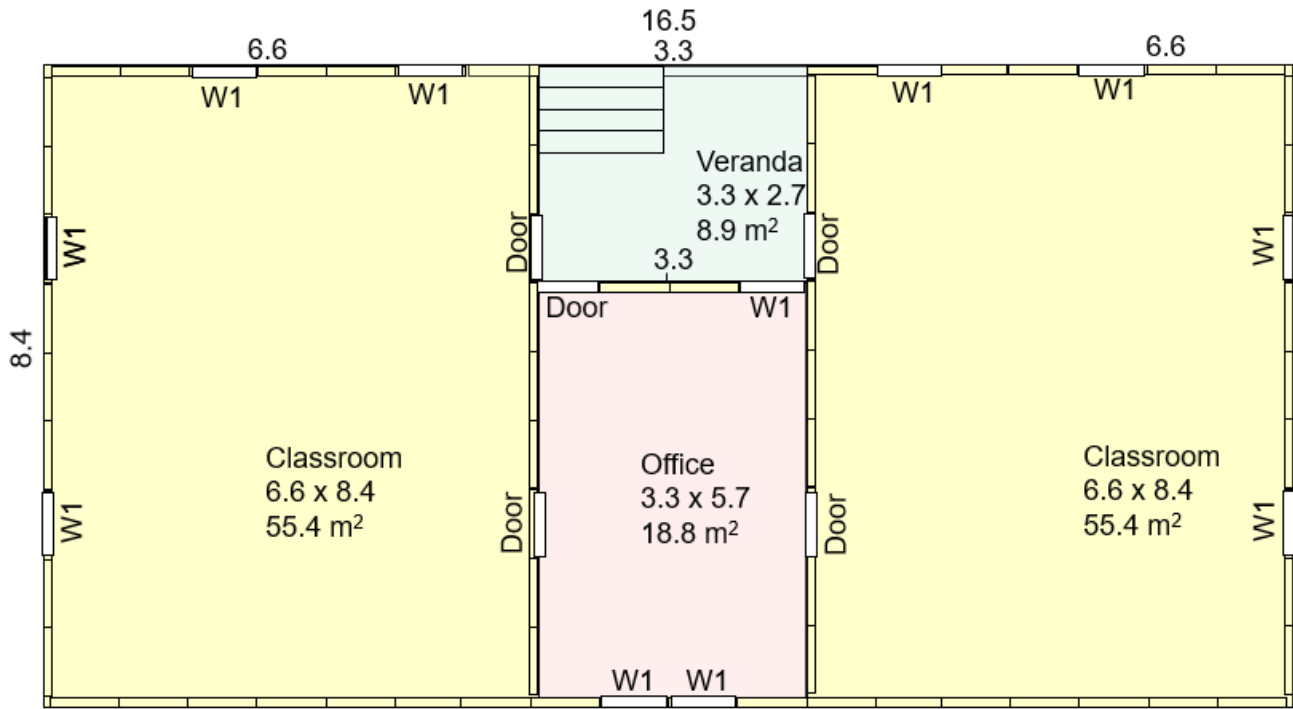

Floor Plan of Left-Hand Class Room, Office and Veranda

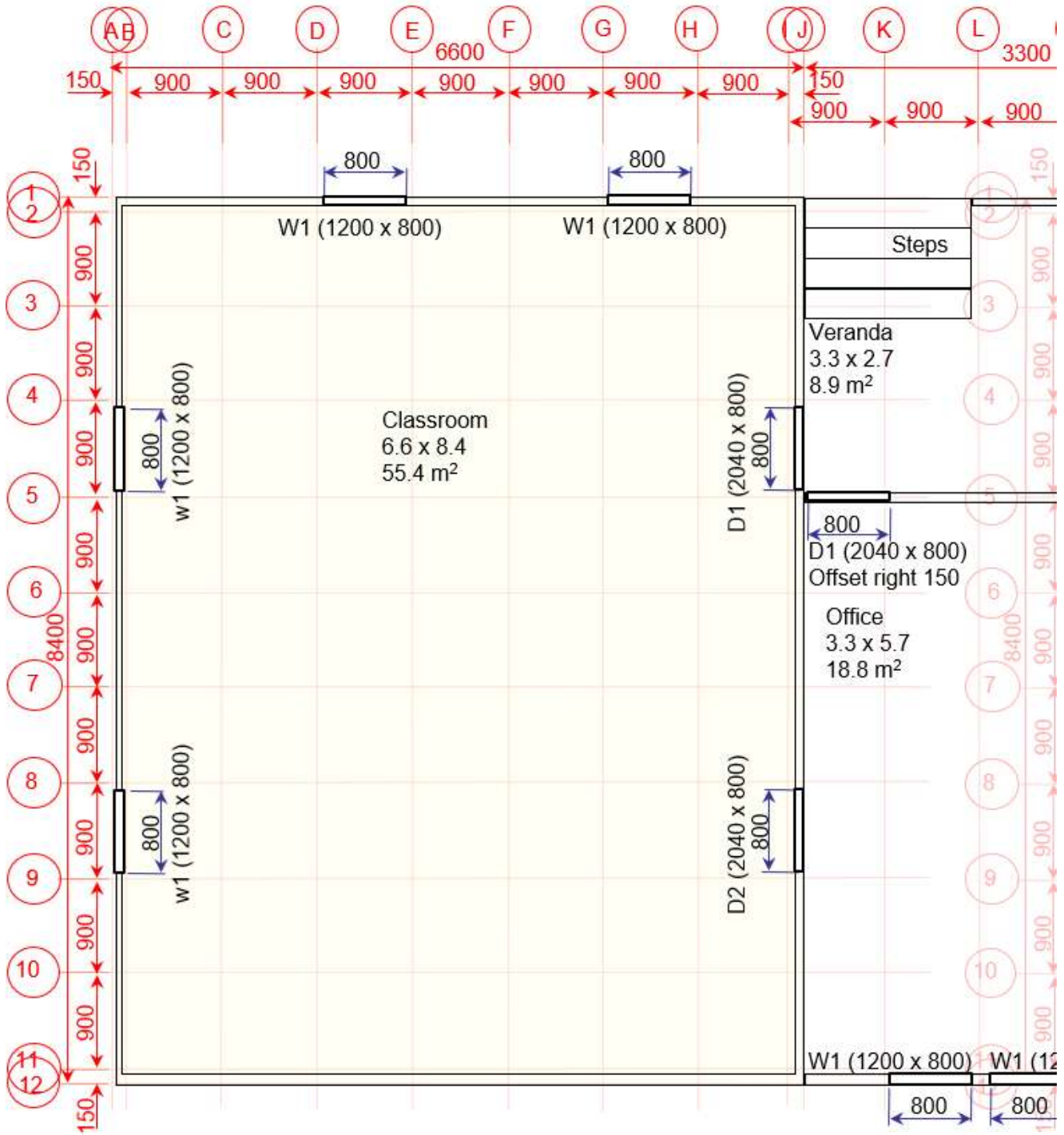

Floor Plan of Left-Hand Class Room, Office and Veranda

Floor Plan of Right-Hand Class Room, Office & Veranda

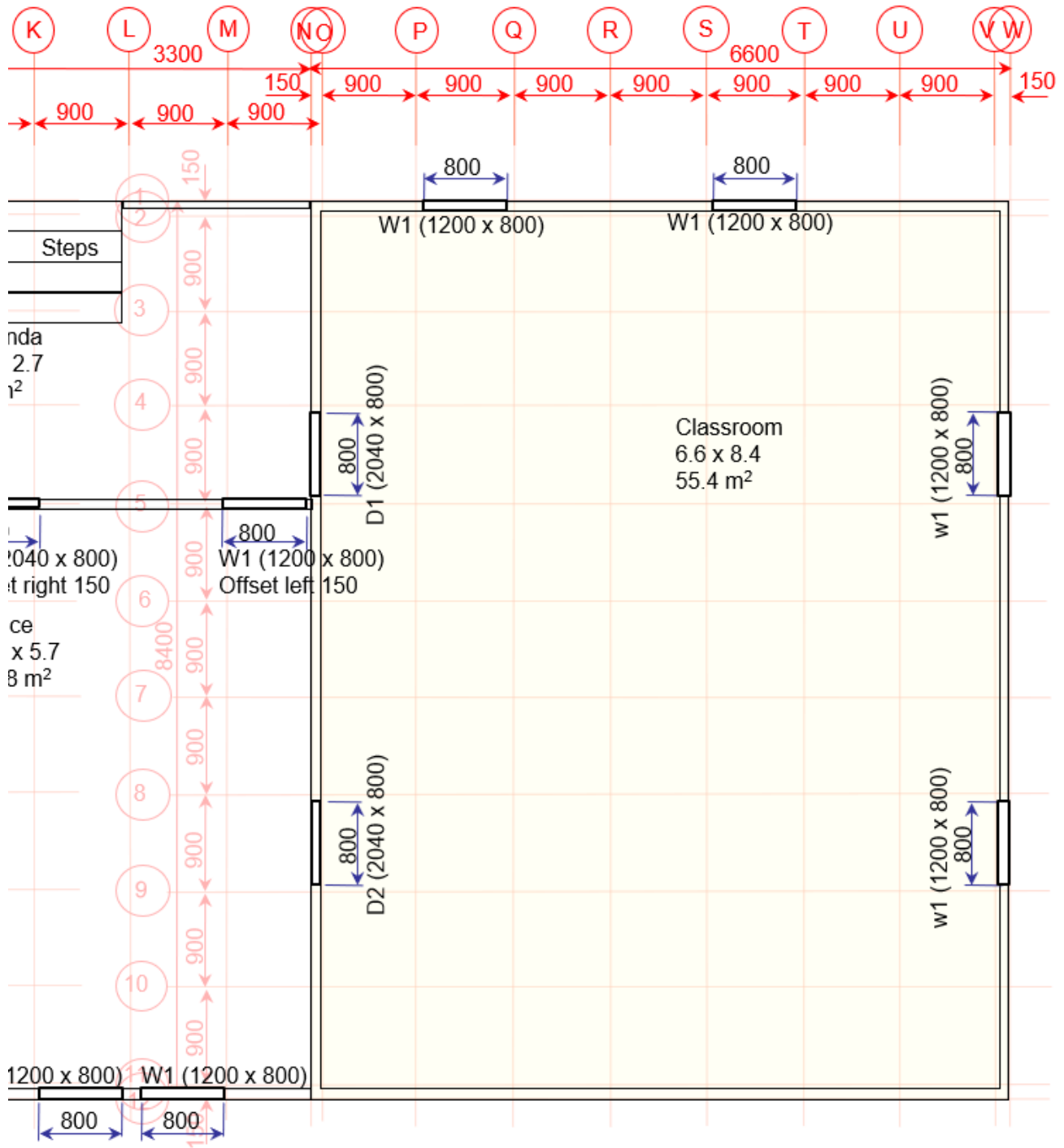

Floor Plan of Right-Hand Class Room, Office and Veranda

Elevations

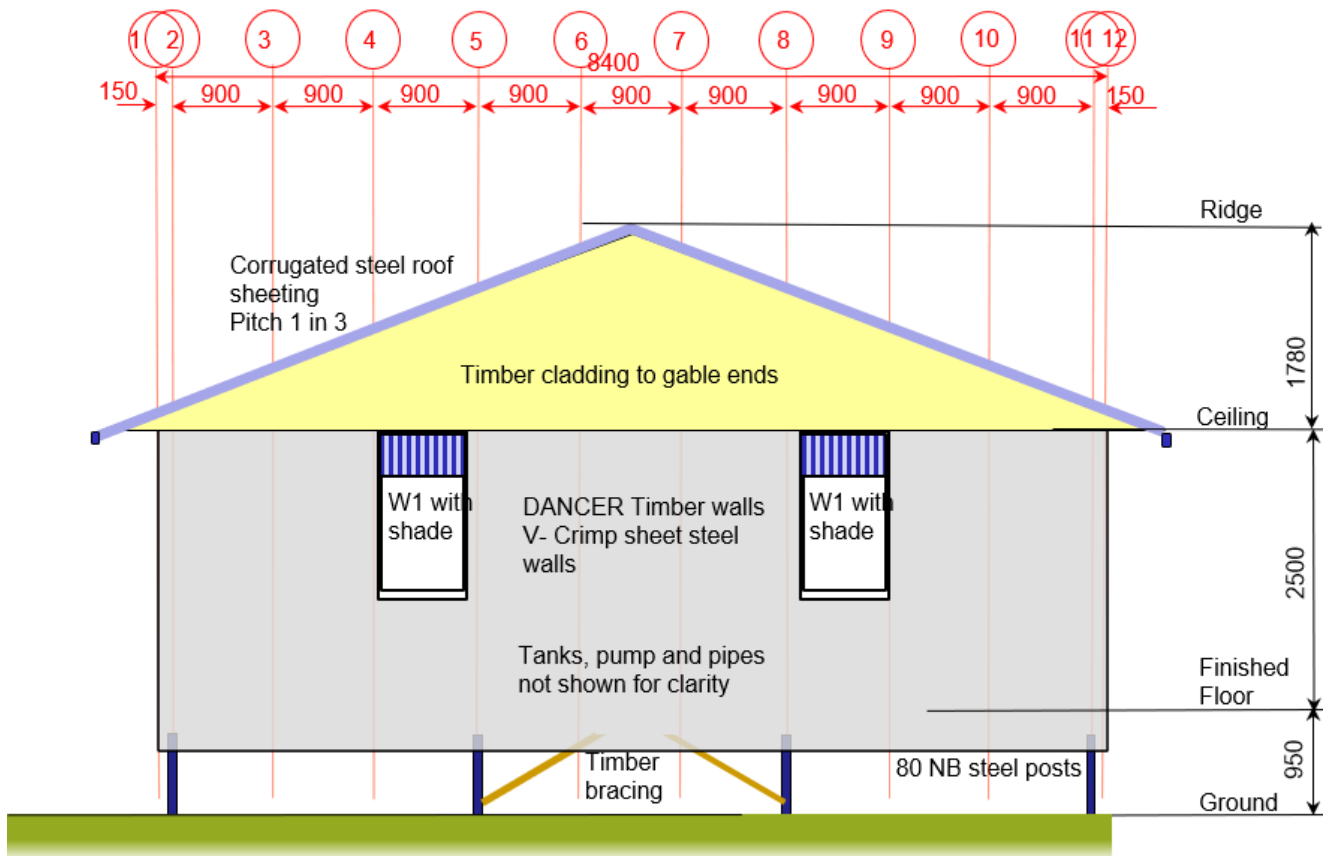

Left End Elevation

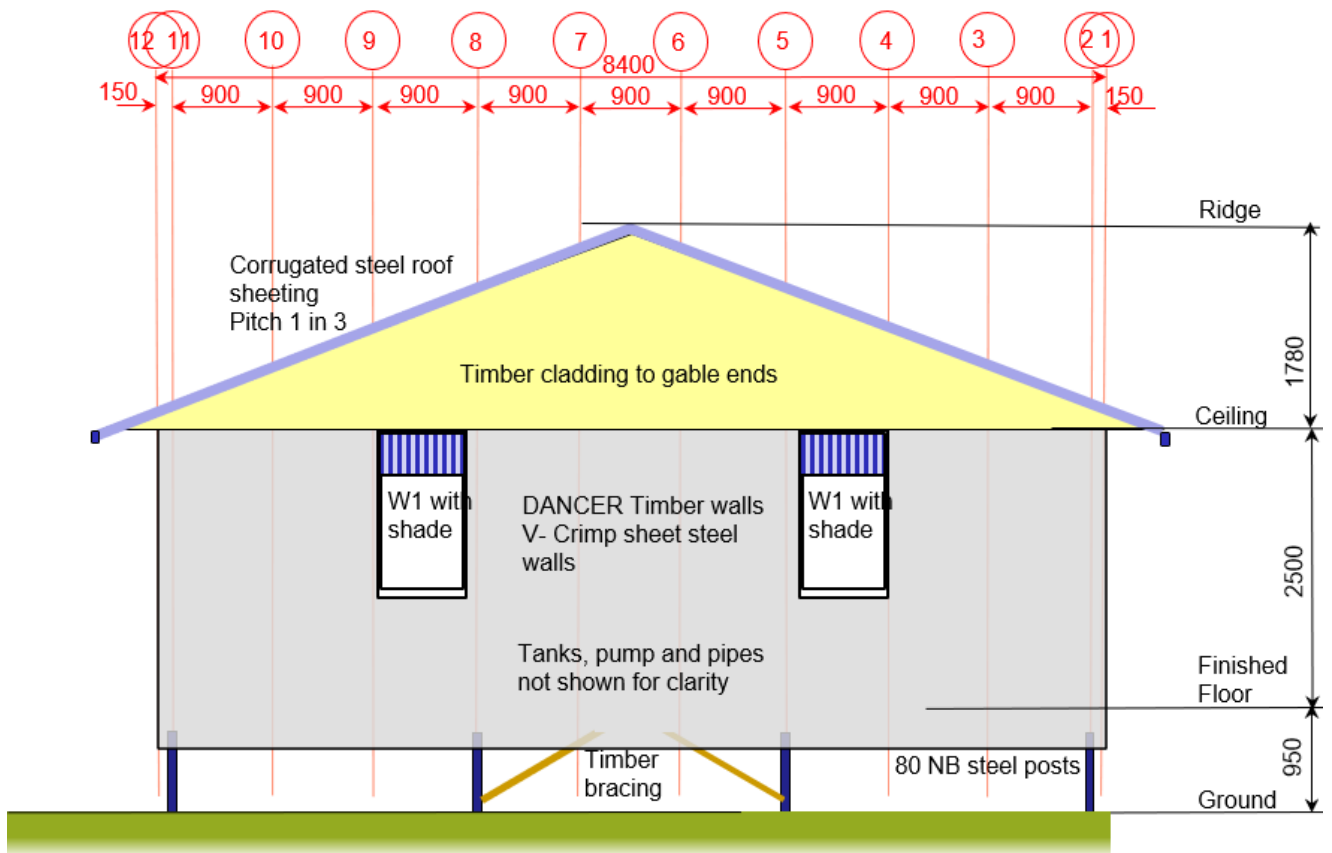

Right End Elevation

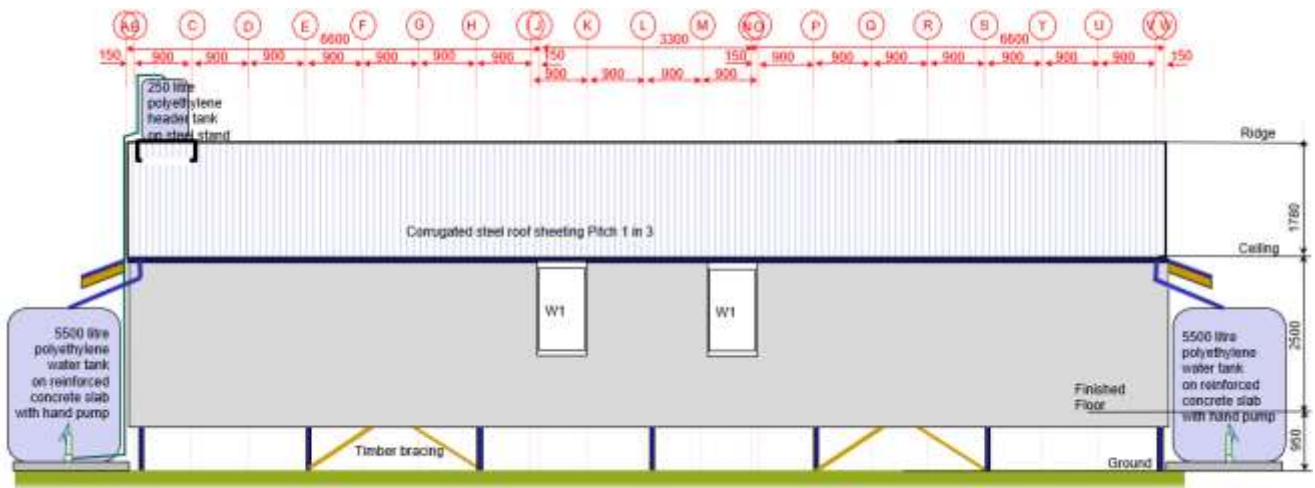

Rear Elevation

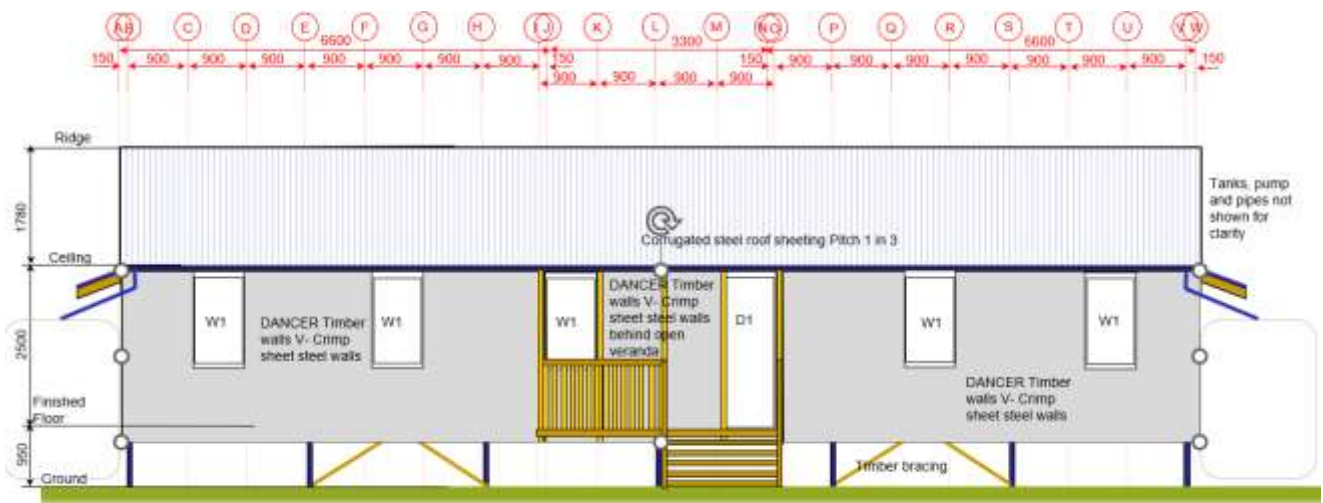

Front Elevation

Sections

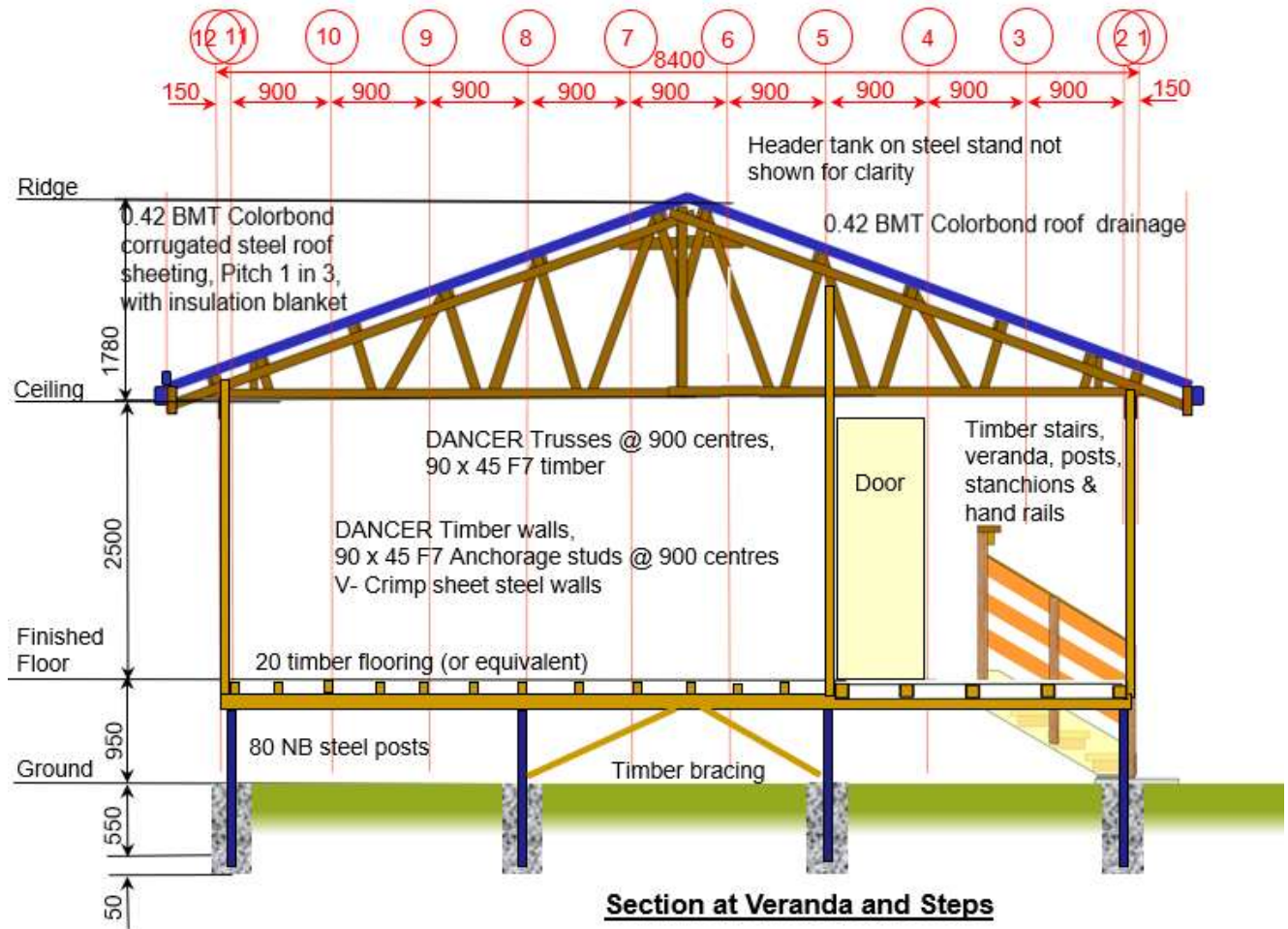

8.4 clear span building in a non-cyclonic environment (DANCER 8.4)

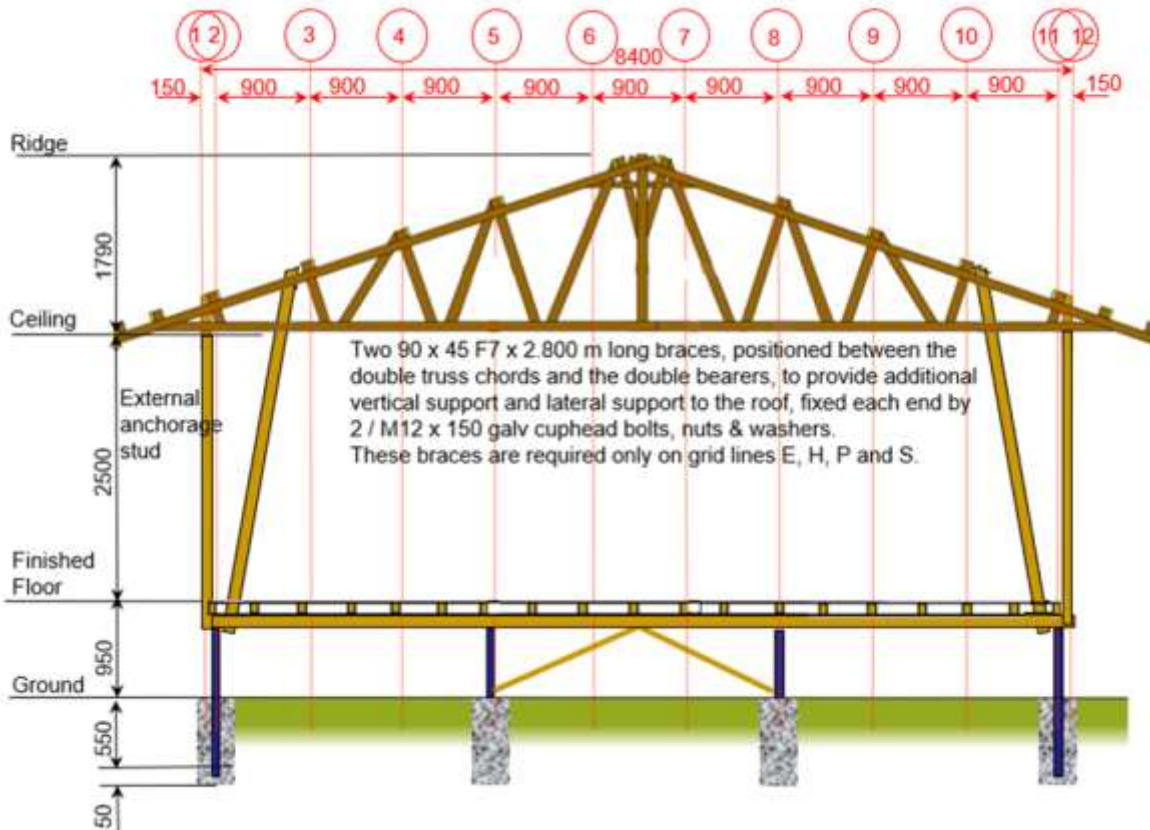

Alternate Option

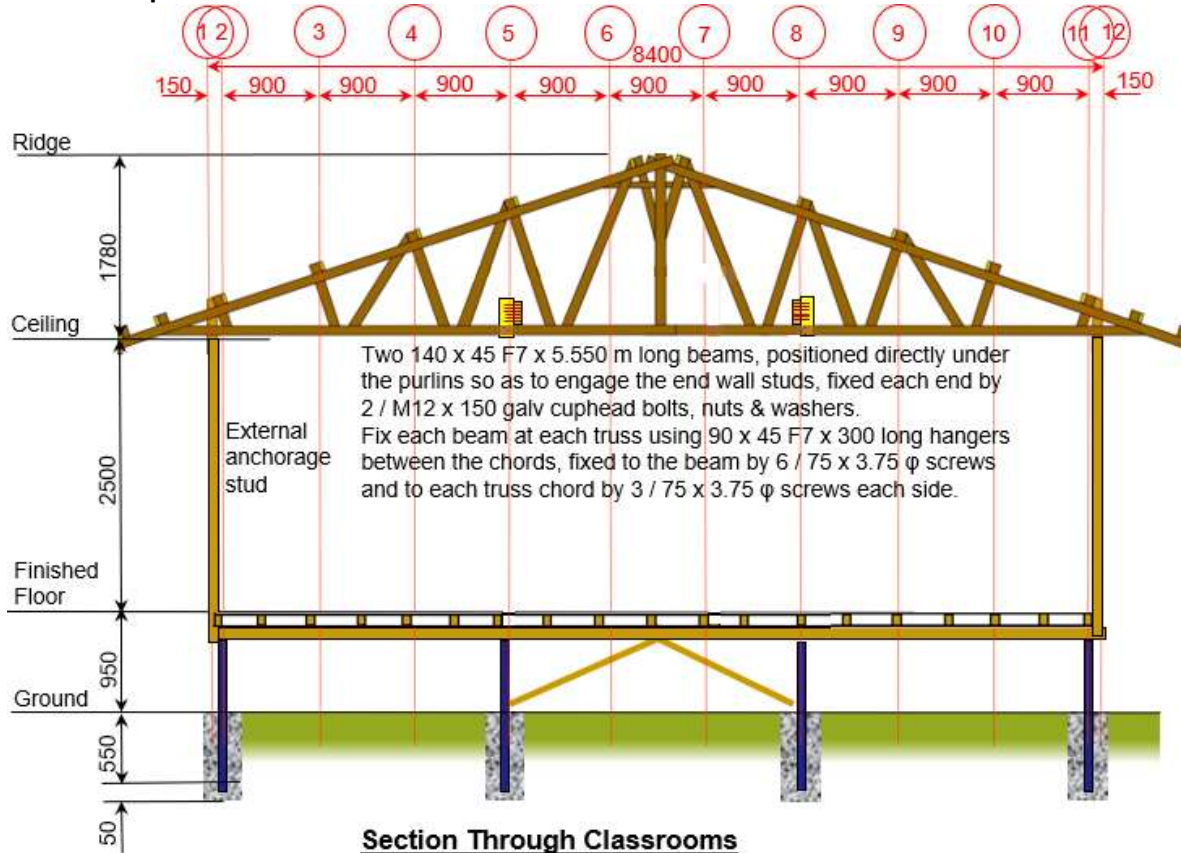

Section Through Classrooms

8.1 maximum clear span trusses x 5.4 maximum between cross walls

Electrical Services

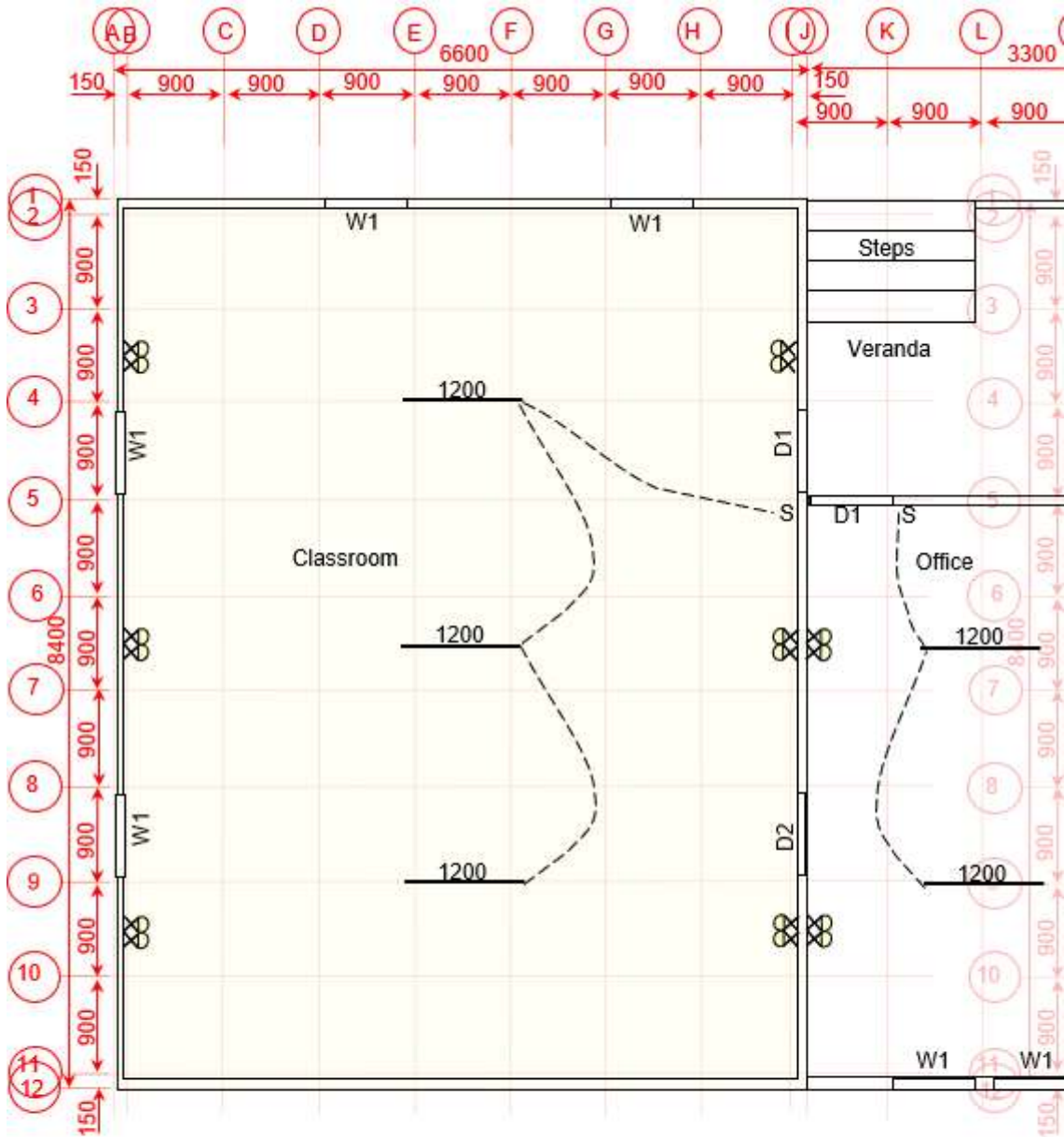

Notes:

1. All electrical installation shall comply with AS 3000 and the Specification, relevant to a 240 volt single-phase supply
2. Mains supply and/or solar power supply to be designed separately.

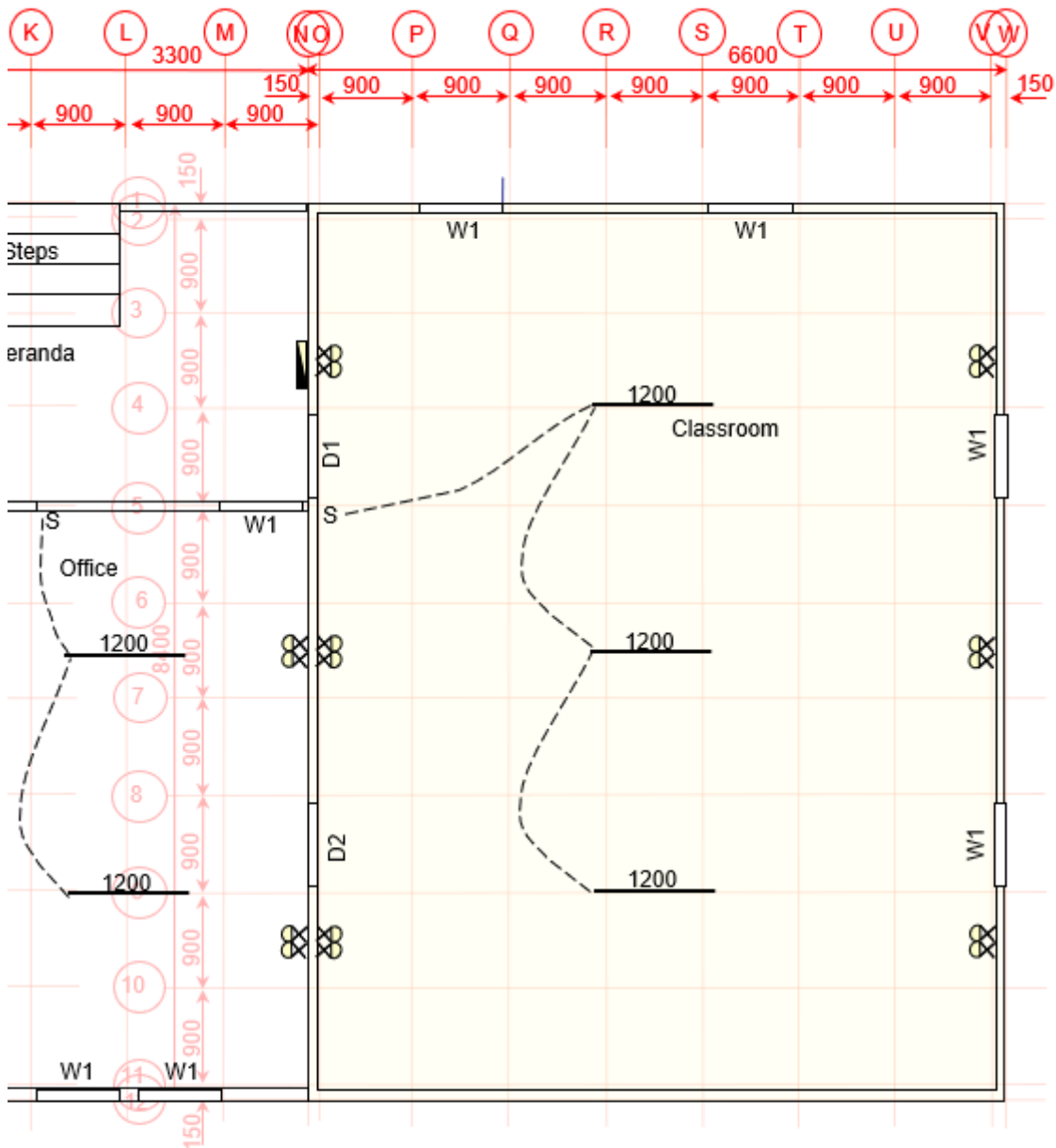

S	Switch, 1200 above floor	1
	Double GPO, 300 above floor	1
	Switch board	1
	Light, 1 x 18W, 613 x 26mm bare batten fluorescent tube	2

Electrical Services
(Left End)



floor
 above floor
 < 26mm
 ant tube

- Notes:
1. All electrical installation shall comply with AS 3000 and the Specification, relevant to a 240 volt single-phase supply
 2. Mains supply and/or solar power supply to be designed separately.

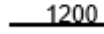
- S Switch, 1200 above floor
-  Double GPO, 300 above floor
-  Switch board
-  Light, 1 x 18W, 613 x 26mm bare batten fluorescent tube

Electrical Services
 (Right End)

Plumbing

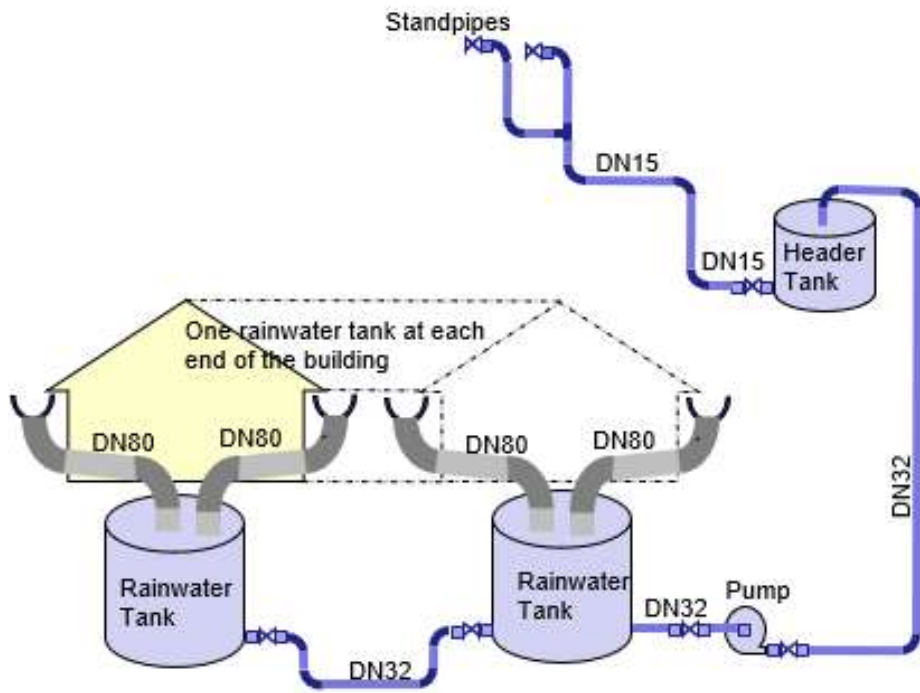

Roof Plumbing

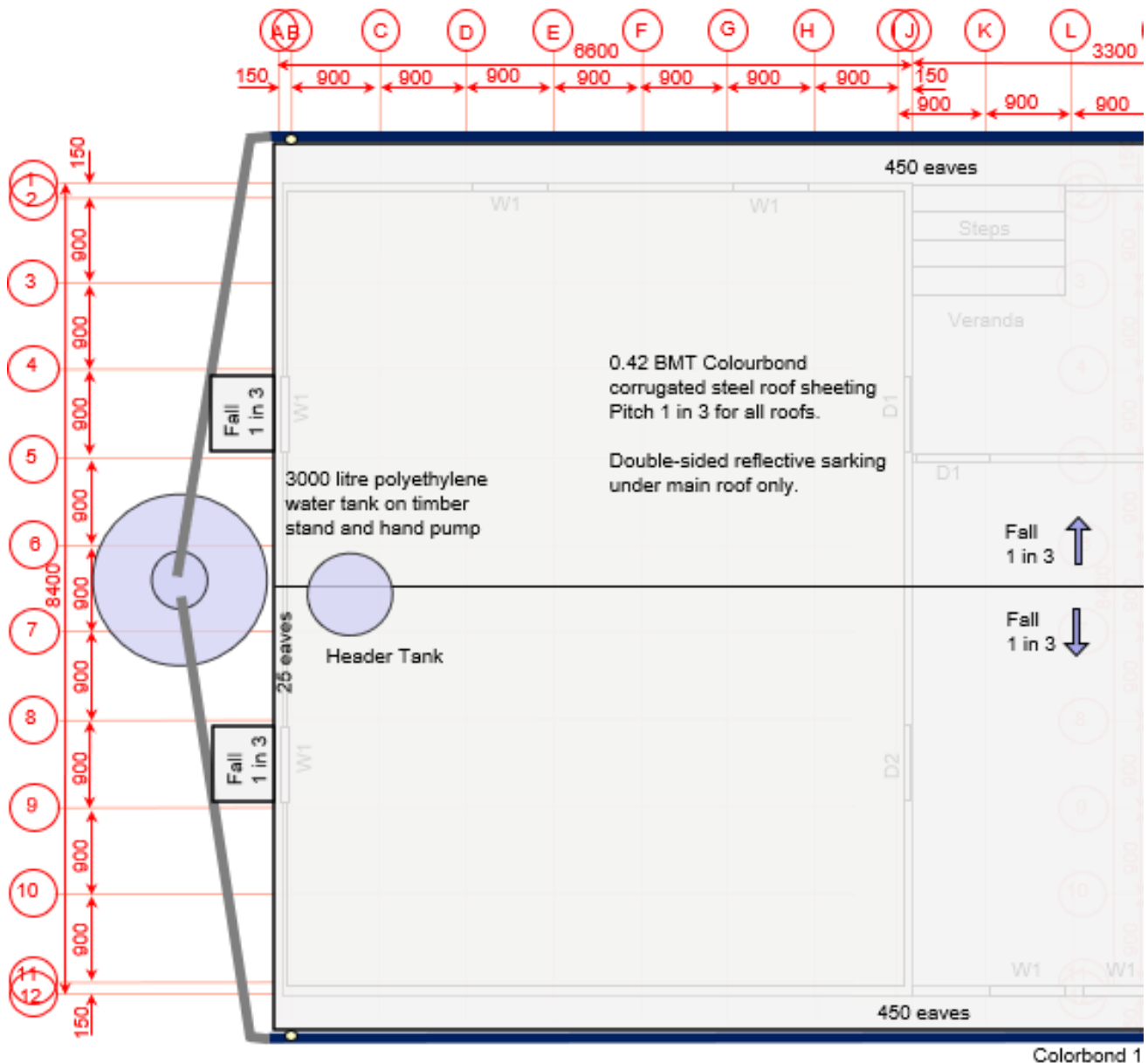

Notes:

- All roofing – 0.42 BMT Colourbond corrugated steel roof sheeting (pitch 1 in 3), fixed with 12-14x35 T17 HD/TG HH Class, top-lock hex galv roofing screws & plastic washers, screw spacing (main part of roof including 1.2 m from ends) – 80 mm (at every rib)
- Sarking (for main roof only) – Double sided reflective insulation placed between roof sheet and timber purlins
Roof Insulation (optional alternative to sarking for main roof only) - R1.8 reflective foil & glass fibre blanket
- Eaves gutter and rainwater collection - DN80 roof drainage (uPVC pipes, inlet & FF 88 elbows). Refer to plumbing schematic for further details.
- Colorbond 100 quad eaves gutter, Colorbond 100 quad stop ends, 12-14x35 T17 HD/TG HH Class 3 screws, Colorbond DN80 clip saddles
- Colorbond steel 200 x 0.6 mm thick ridge flashing, Colorbond steel 0.6 mm thick barge moulds, fixings galv roofing nails 65 x 3.75mm and jolt head nails 125 x 5.8mm fixings for flashing & barge moulds

Roof Cladding and Drainage (Left End)

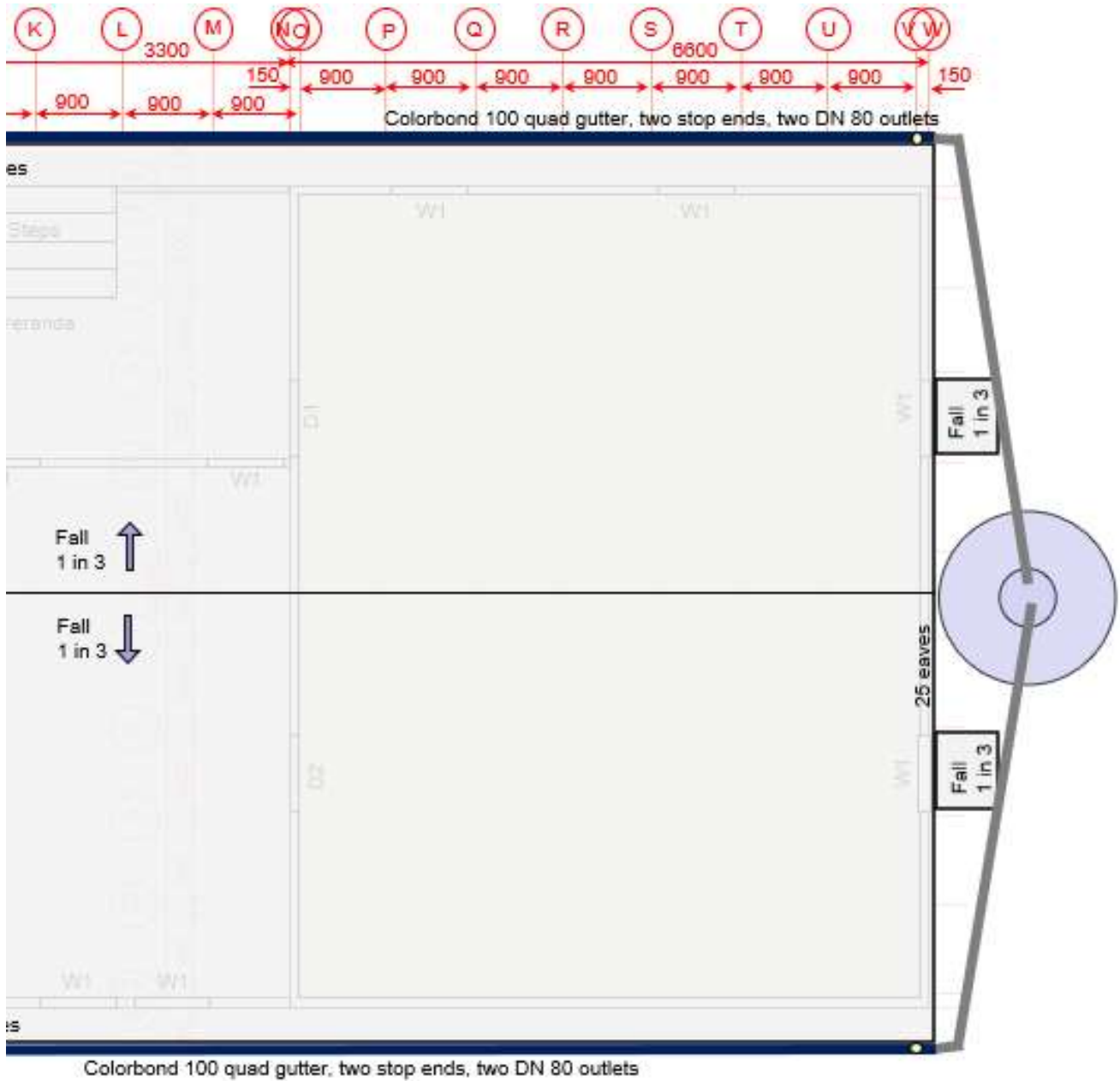

5 T17
 f roof
 iber
 efer to
 s 3
 ings
 s

Roof Cladding and Drainage
 (Right End)

Engineering Design

Dancer Building System

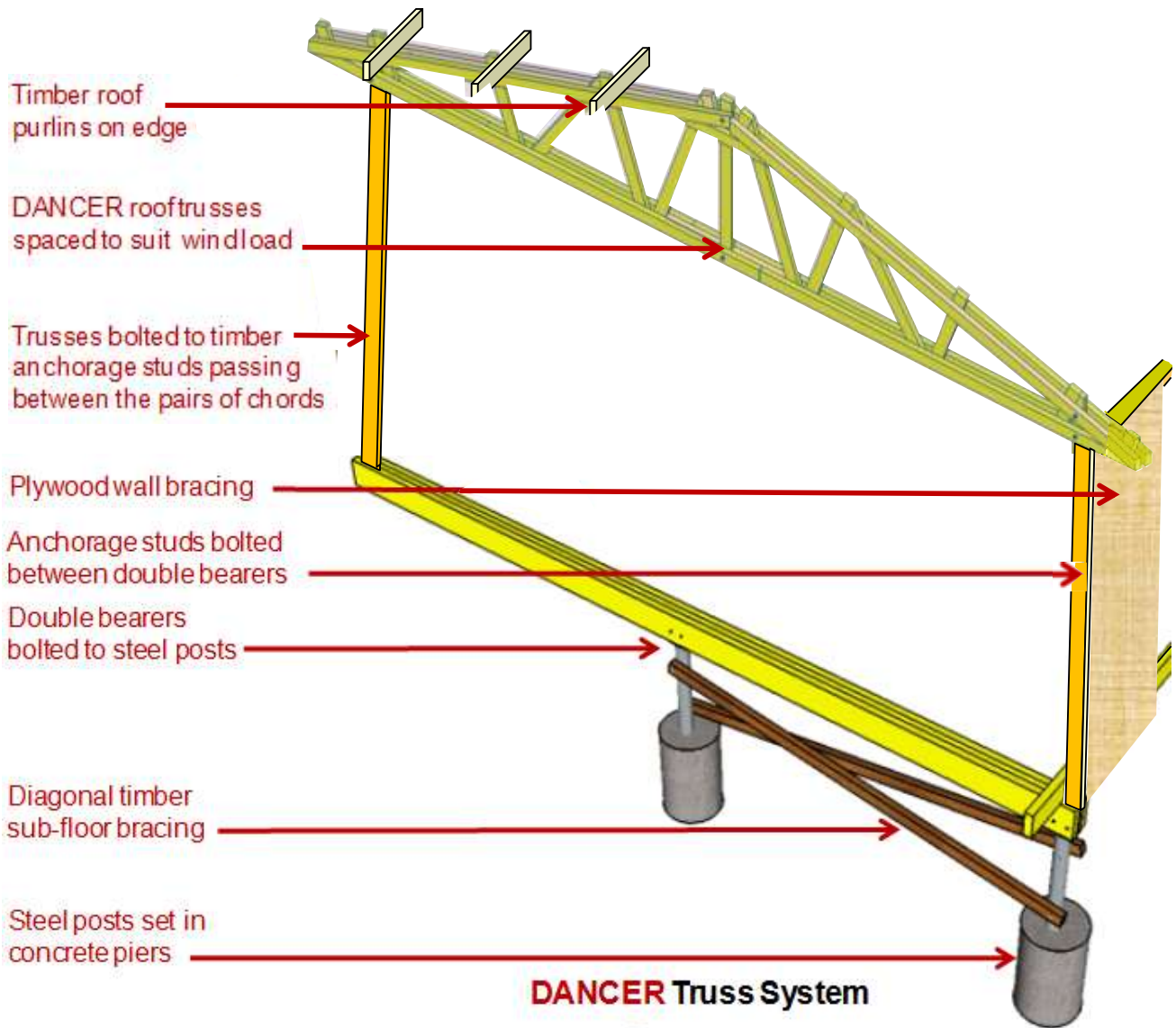

Gridlines

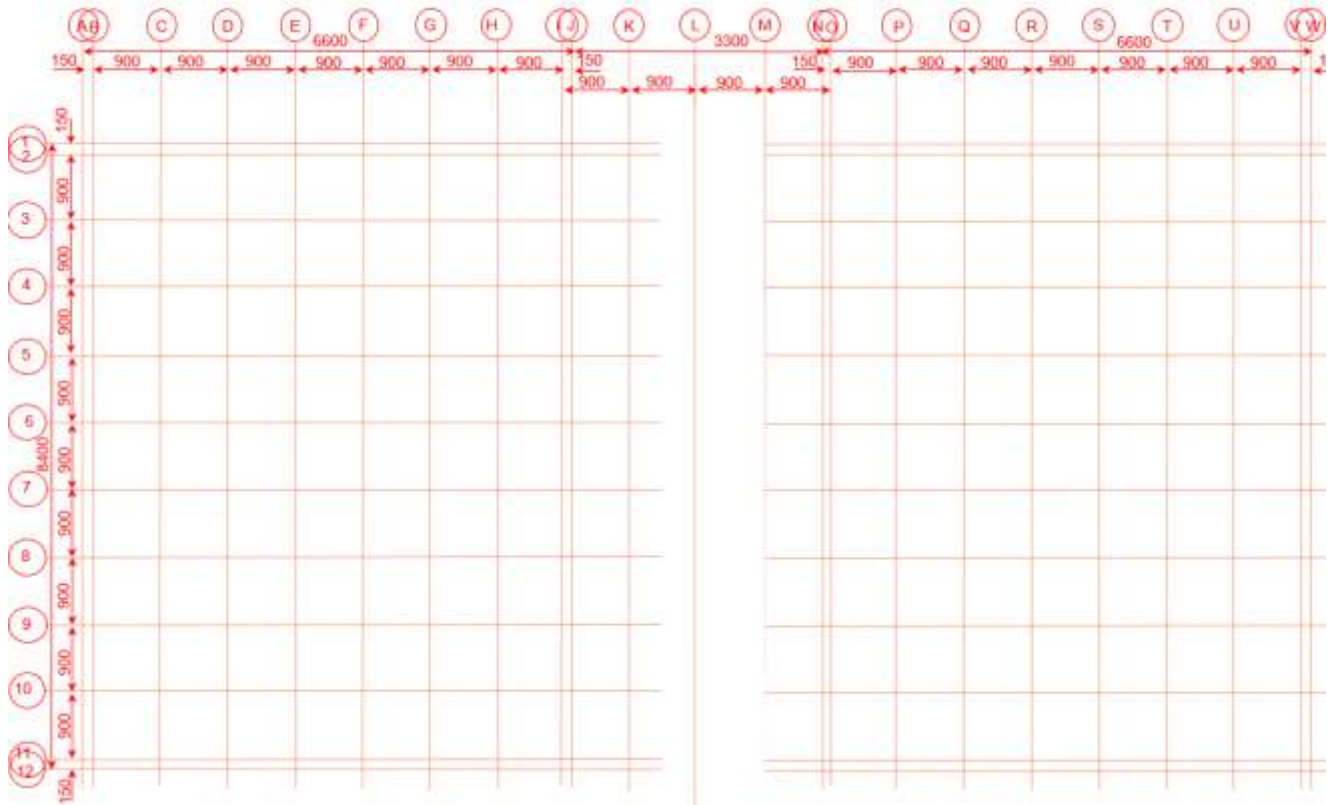

Subfloor Pier, Post and Bracing Arrangement

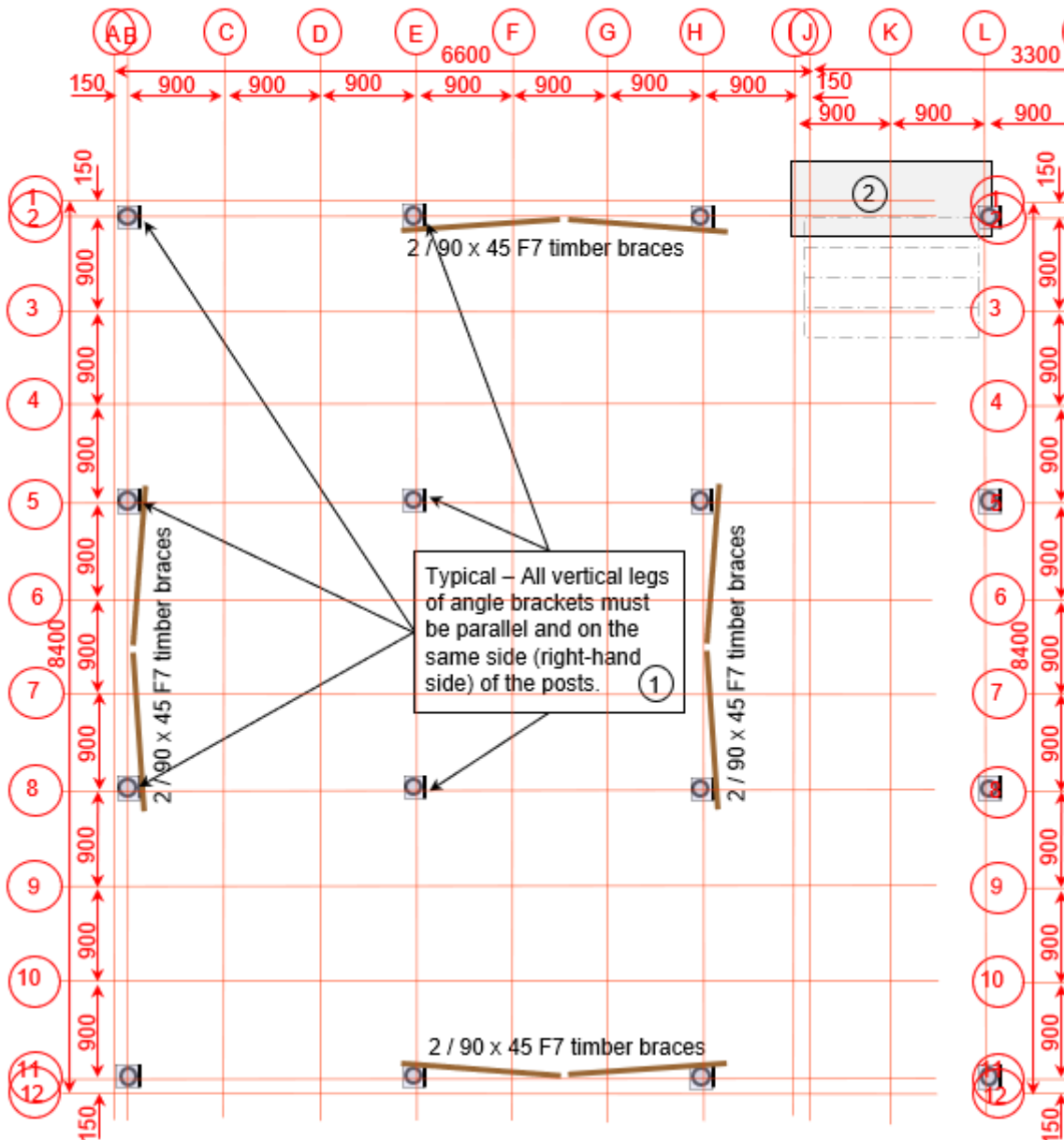

- ① Concrete piers, 400 diameter x 600 deep. Steel Posts – 80 NB x 6.5 galvanized pipe x 1194 long, with 125 x 75 x 6 L x 150, drilled 2-14 mm holes, 6 cfw (continuous fillet weld) to top of pipe, and 2-10 dia x 150 bars 6 cfw (continuous fillet weld) to bottom of pipe
- ② Concrete Pad at base of steps – 2,000 x 600 x 100 mm thick, 5 / N10 x 550 reinforcing bars, 3 / N10 x 1150 reinforcing bars. Top surface nominally 60 mm above ground level.

Notes:

1. N20 Concrete
2. For all other items, substitution of other sizes must be approved by the Engineer.
3. Refer to Engineer's Details for fixings, connections and associated members.

Subfloor Pier, Post and Bracing Arrangement

Bearer & Joist Arrangement

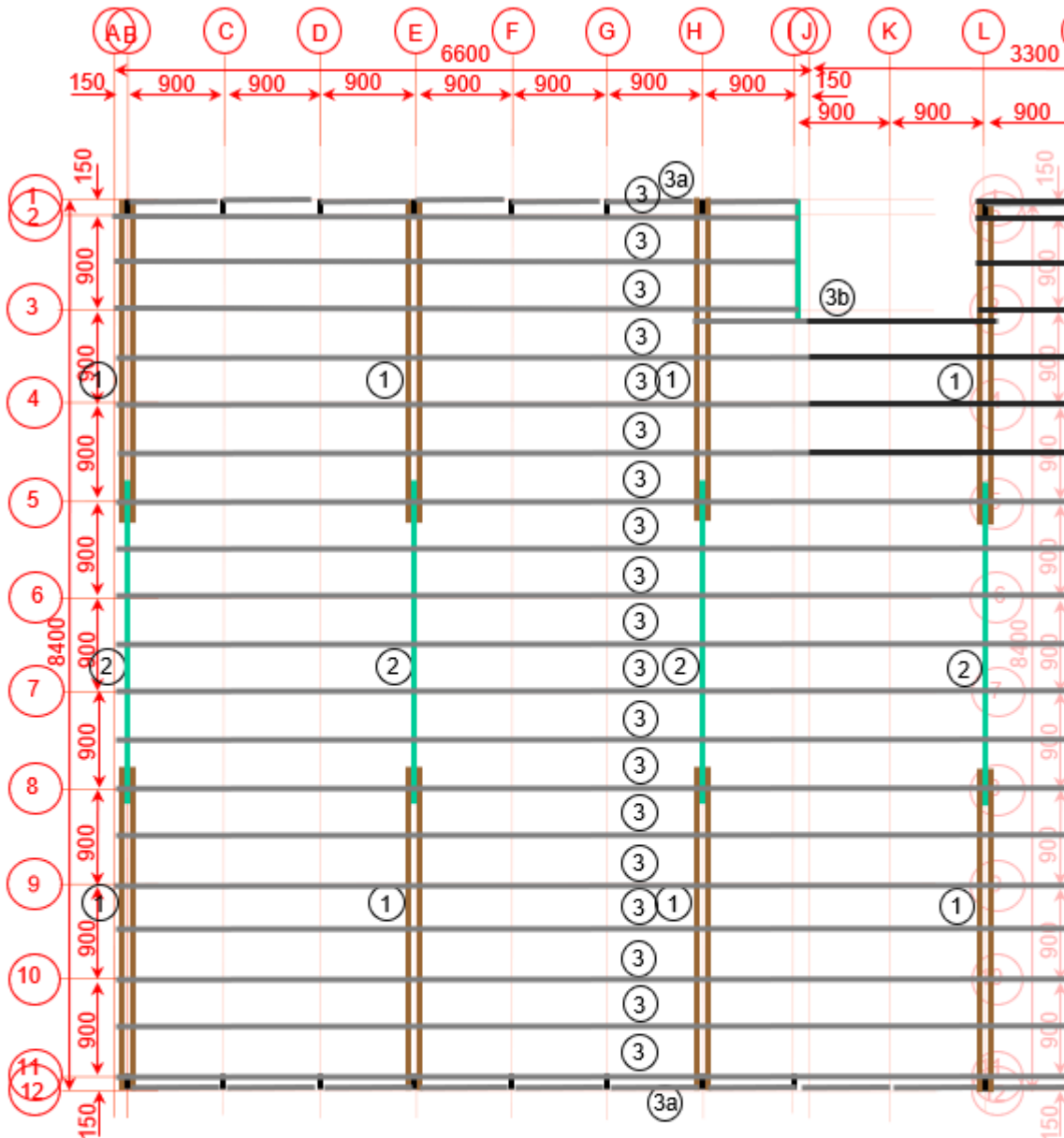

- ① Double Bearers (2 / 140 x 45 x 3000 long, lapped)
- ② Single Bearers (1 / 140 x 45 x 3000 long, lapped)
- ③ Joists (90 x 45 x 3000 long, lapped)

Notes:

1. All timber shall be graded F7, SD6, JD4 or stronger. Australian and New Zealand Seasoned Radiata Pine are deemed to meet this specification.
2. For all other items, substitution of other sizes must be approved by the Engineer.
3. Refer to Engineer's Details for fixings, connections and associated members.

Bearer & Joist Arrangement (Left End)

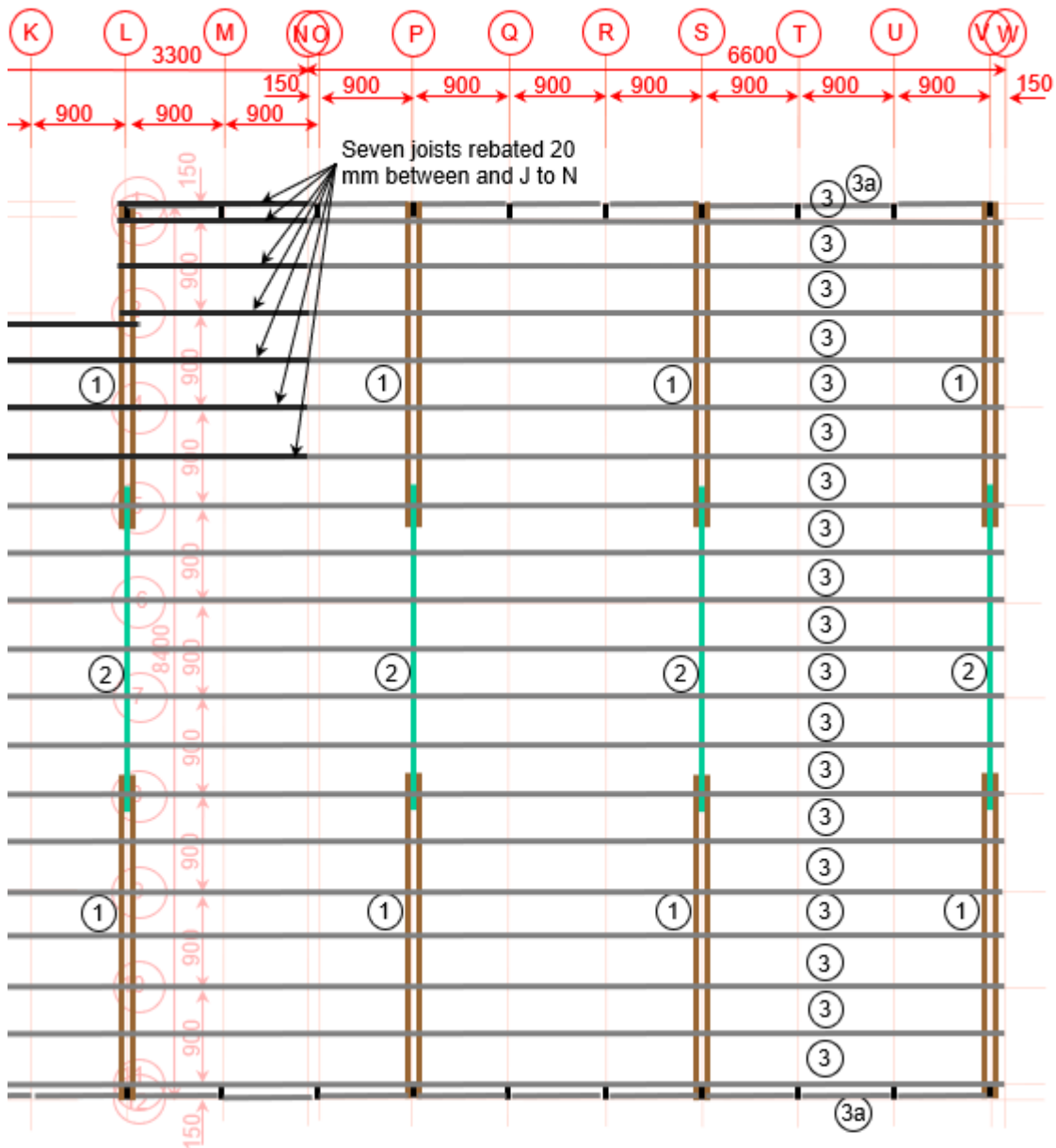

- ① Double Bearers (2 / 140 x 45 x 3000 long, lapped)
- ② Single Bearers (1 / 140 x 45 x 3000 long, lapped)
- ③ Joists (90 x 45 x 3000 long, lapped)

Notes:

1. All timber shall be graded F7, SD6, JD4 or stronger. Australian and New Zealand Seasoned Radiata Pine are deemed to meet this specification.
2. For all other items, substitution of other sizes must be approved by the Engineer.
3. Refer to Engineer's Details for fixings, connections and associated members.1

Bearer & Joist Arrangement
(Right End)

Roof Truss, Purlin & Bracing Arrangement

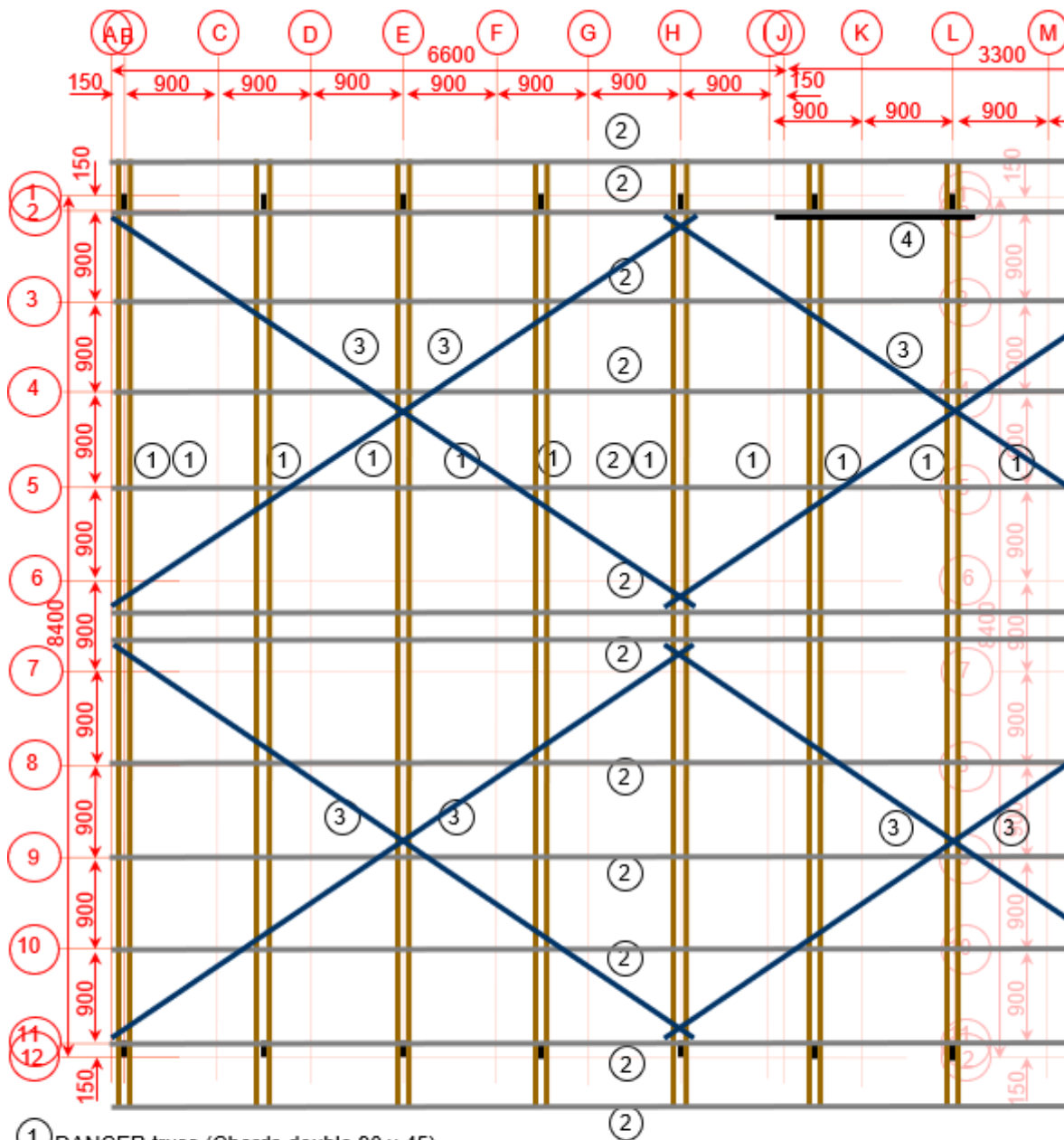

- ① DANCER truss (Chords double 90 x 45)
- ② Purlin P1 (90 x 45)
- ③ Steel strap (30 x 1) ④ Veranda beam (140 x 45)

Notes:

1. All timber shall be graded F7, SD6, JD4 or stronger. Australian and New Zealand Seasoned Radiata Pine are deemed to meet this specification.
2. For all other items, substitution of other sizes must be approved by the Engineer.
3. Refer to Engineer's Details for fixings, connections and associated members.

Roof Truss, Purlin & Bracing Arrangement (Left End)

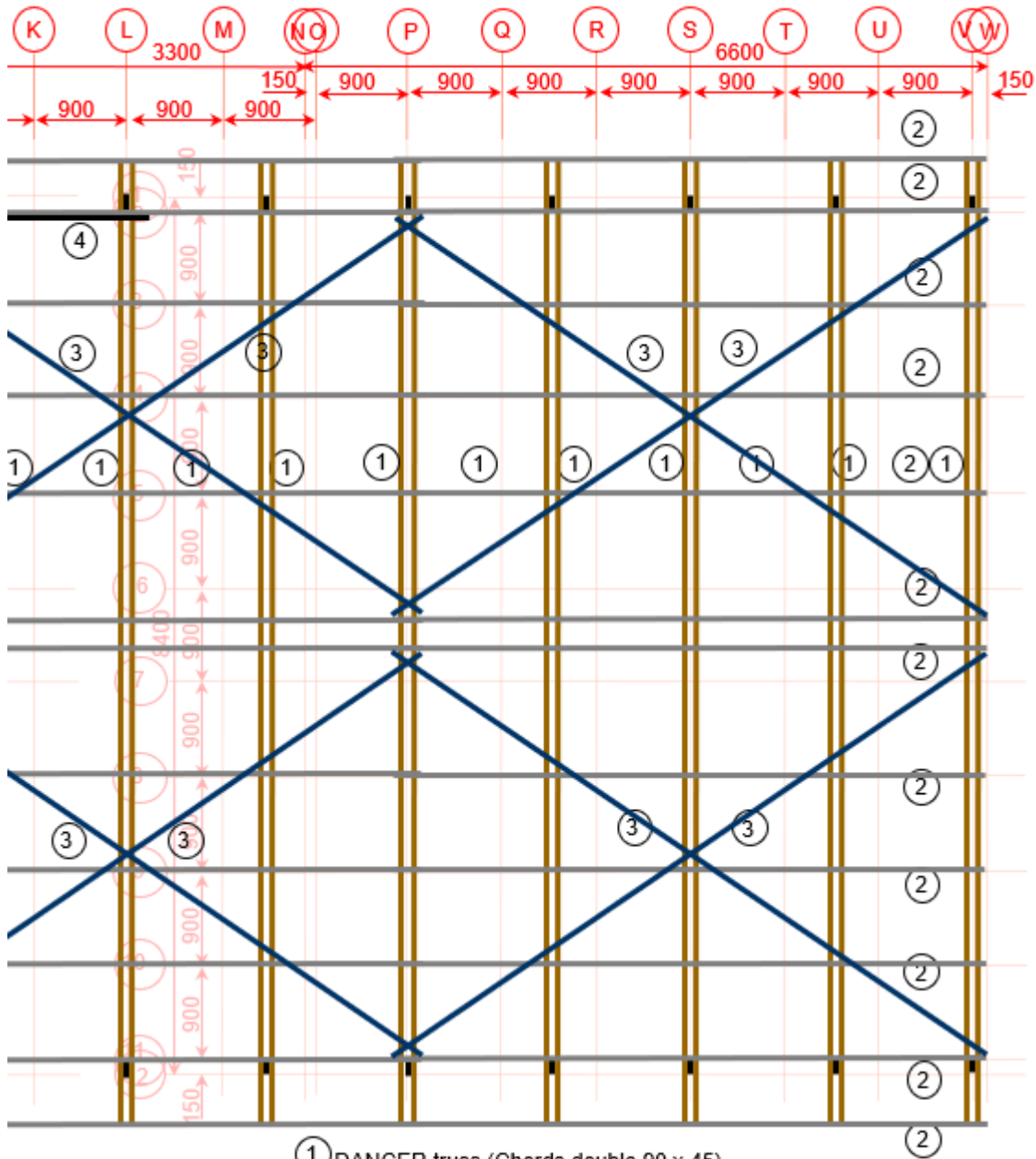

- ① DANCER truss (Chords double 90 x 45)
 ② Purlin P1 (90 x 45)
 ③ Steel strap (30 x 1) ④ Veranda beam (140 x 45)

Notes:

1

1. All timber shall be graded F7, SD6, JD4 or stronger. Australian and New Zealand Seasoned Radiata Pine are deemed to meet this specification.
2. For all other items, substitution of other sizes must be approved by the Engineer.
3. Refer to Engineer's Details for fixings, connections and associated members.1

Roof Truss, Purlin & Bracing Arrangement
 (Right End)

Details of **DANCER** Trusses

The following dimensions are for the Standard **DANCER** 8.4 Truss, with eaves overhang of 450 mm. All members shall be 90 x 45 MGP10 Strength group SD5, Joint group JD4 (or better)

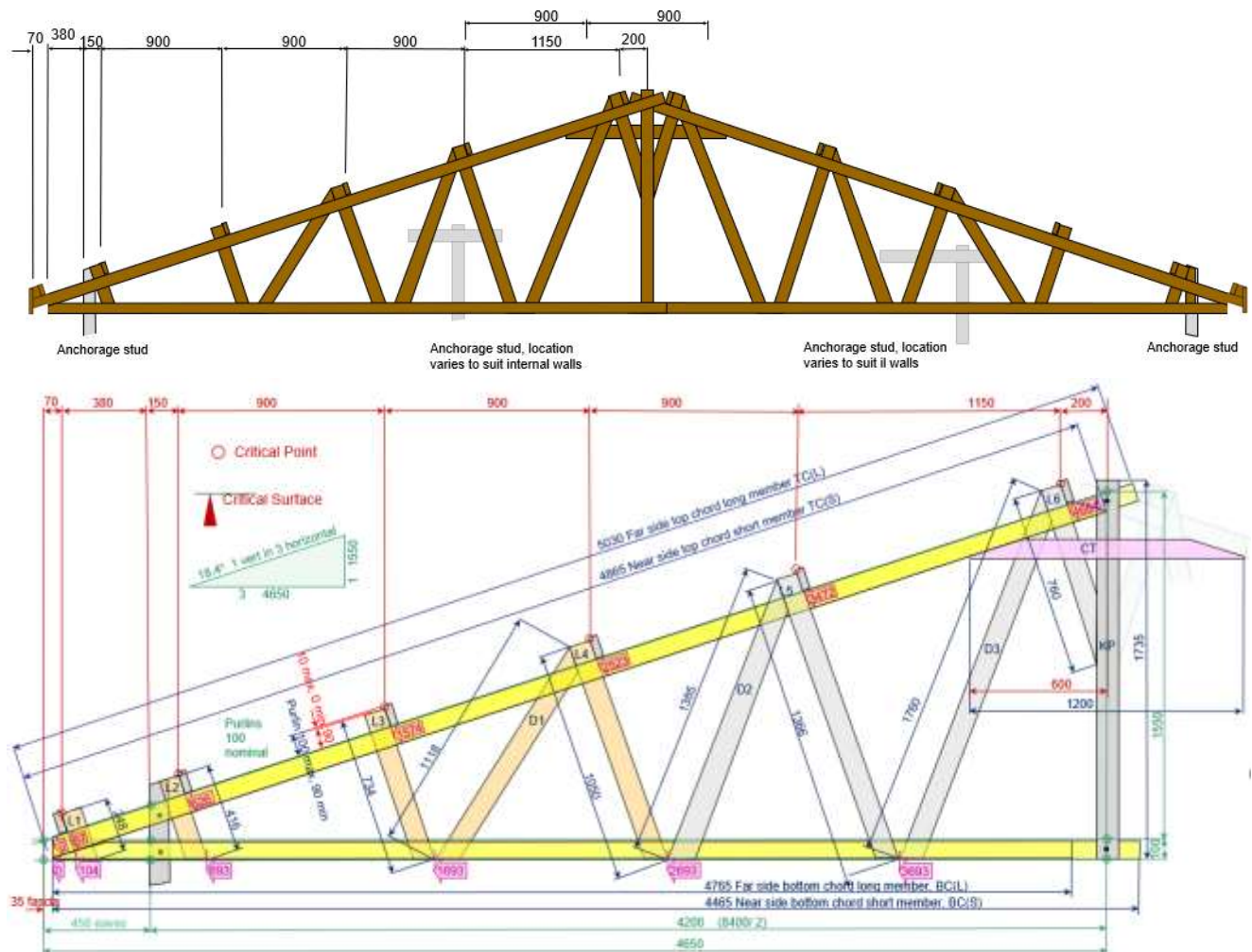

Roof Trusses					8.400
Item	Component	Section mm x mm	Material		Length mm
TC(L)	Truss Top Chord (or R	90 x 45	F7		5,030
TC(S)	Truss Top Chord (or R	90 x 45	F7		4,865
BC(L)	Truss Bottom Chord (a	90 x 45	F7		4,765
BC(S)	Truss Bottom Chord (a	90 x 45	F7		4,465
CT	Collar Tie	90 x 45	F7		1,200
KP	King Post	90 x 45	F7		1,735
L1	Lacing at eaves	90 x 45	F7		248
L2	Lacing at anchorage st	90 x 45	F7		416
L3	Lacing	90 x 45	F7		734
L4	Lacing	90 x 45	F7		1,050
L5	Lacing	90 x 45	F7		1,366
L6	Lacing	90 x 45	F7		760
D1	Diagonal	90 x 45	F7		1,118
D2	Diagonal	90 x 45	F7		1,385
D3	Diagonal	90 x 45	F7		1,762

DANCER Truss Bolted Apex Splice

Trusses longer than 3.5 metres cannot be easily transported over significant distances.

They must be fabricated in two sections and joined on site. In this case the top chords must be joined with a bolted connection, and the bottom chords must be joined by a bolted connection.

Bolted connections must not incorporate nails, since the premature failure of the nails could disrupt the timber and destroy the bolted connection before it has time to be effective.

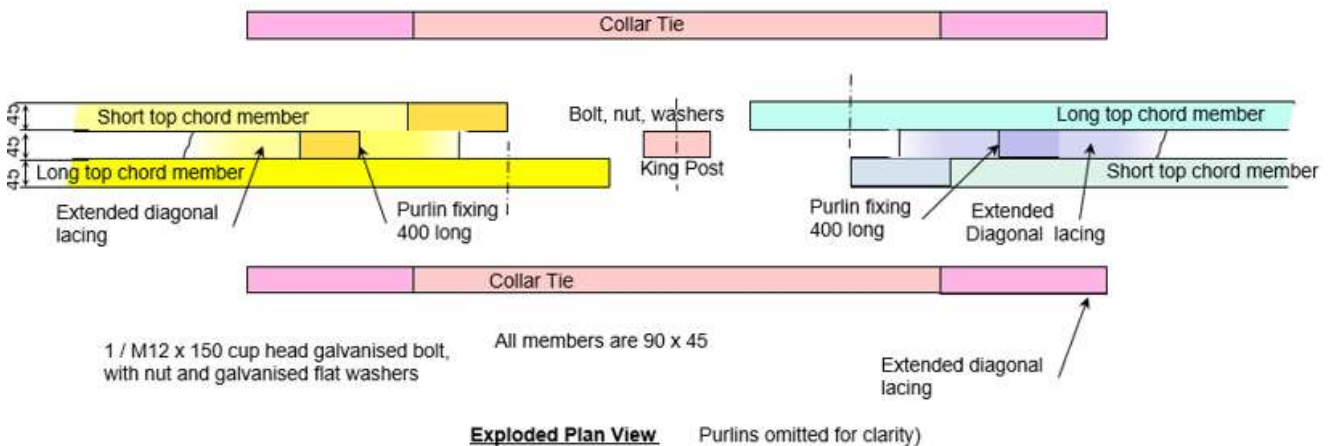
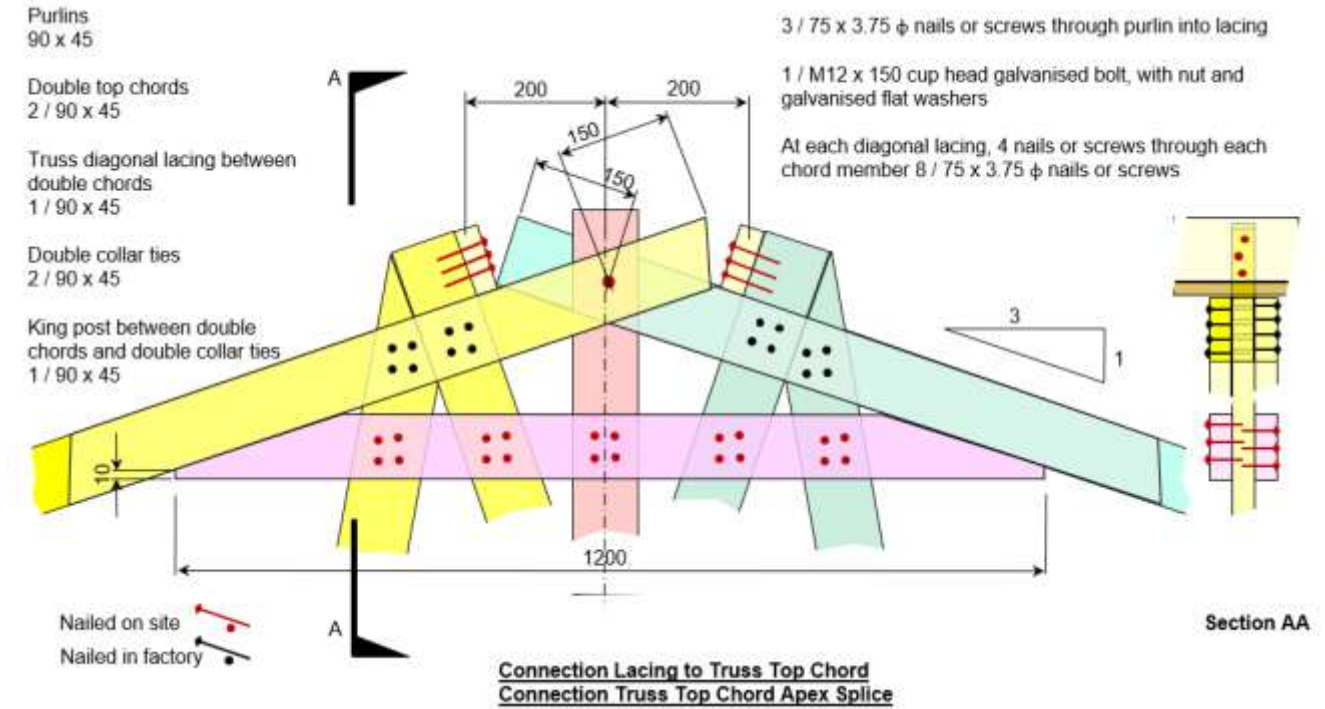

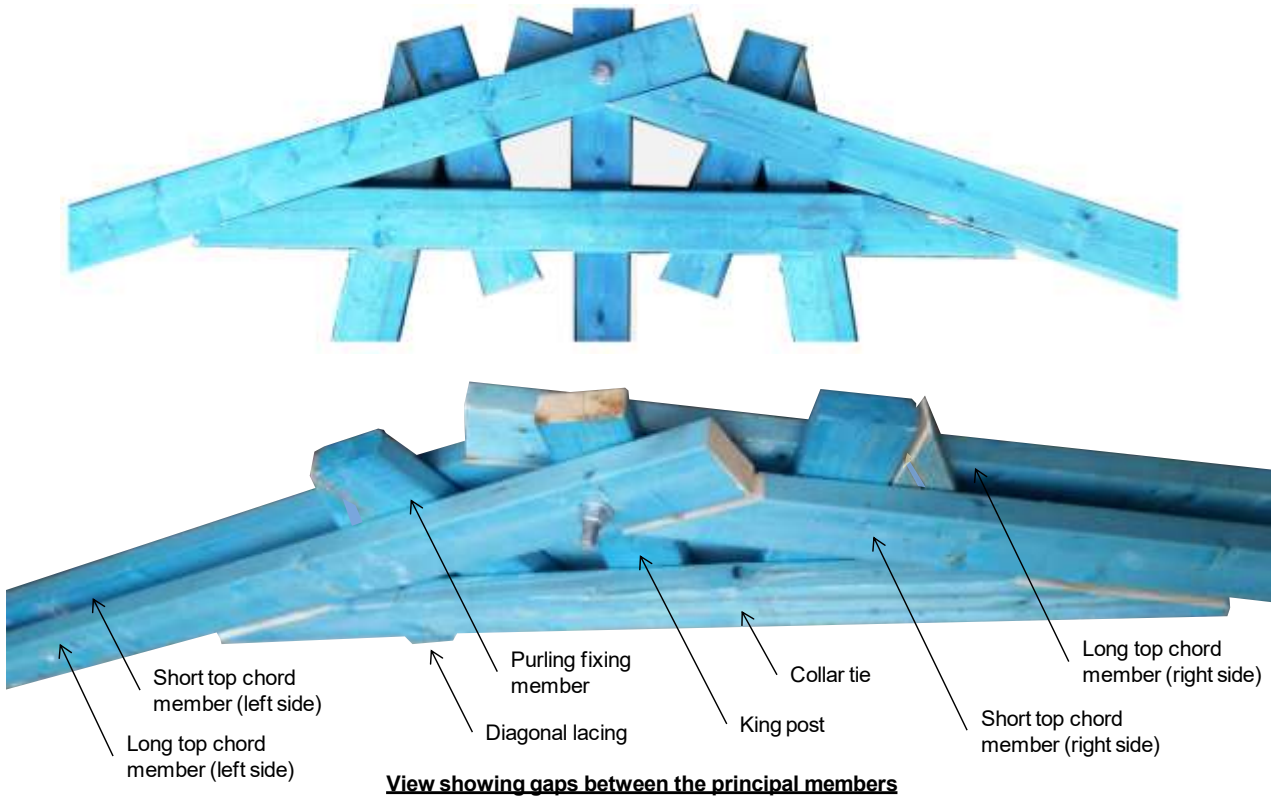

DANCER Truss Bolted Bottom Chord Splice

The Bottom Chords shall be spliced in a lapped double chord arrangement (similar to the top chord).

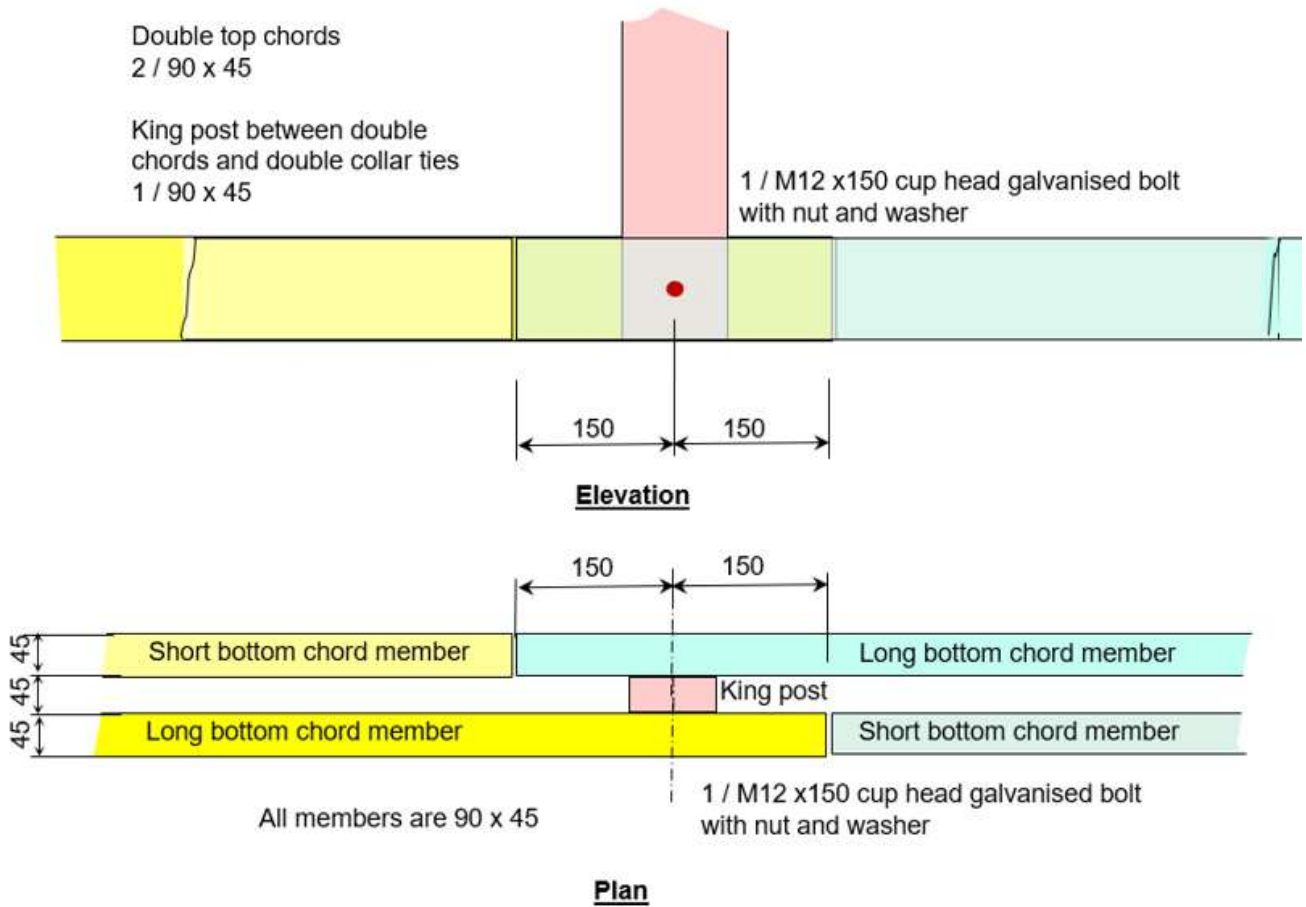

Connection Truss Bottom Chord Splice

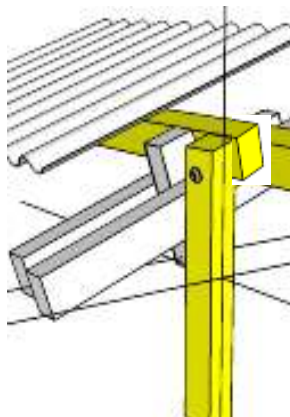
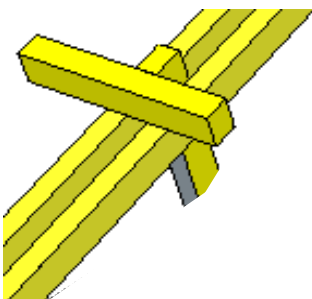

Purlin, Diagonal Lacing and Double Top Chord Connections

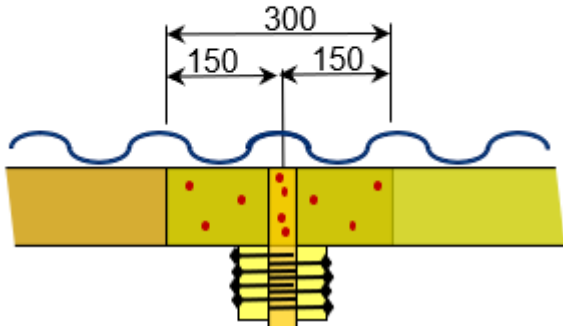
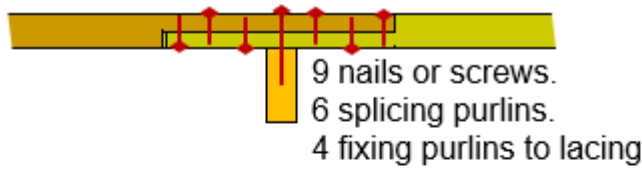

4 nails or screws through each chord into each lacing member (inserted between)



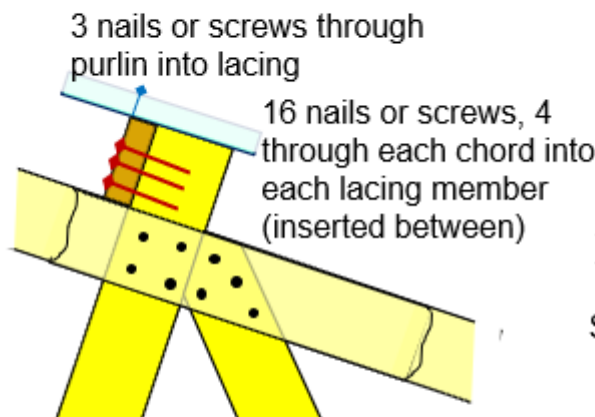

Purlin Splice (Preferred Detail)

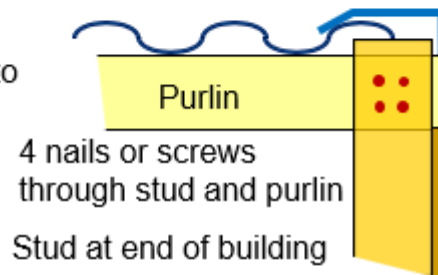

**Connection Purlin to Double Top Chord
Connection Lacing to Double Top Chord**



Connection Purlin to End Wall Stud

Nailed on site 
Nailed in factory 
75 x 3.75 ϕ nails or screws   Purlins, double chords and truss diagonal lacing between double chords 90 x 45 F7 timber

Top Chord, Lacing, Purlin Fixing and Purlin Splice

Double Bottom Chord, Anchorage Stud and Eaves Connections

75 x 3.75 ϕ nails or screws

Fixed in factory

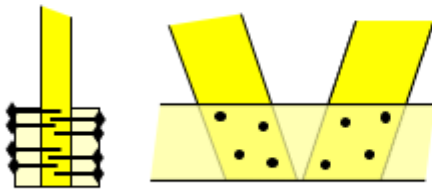

Purlins, double chords and truss diagonal lacing between double chords are all 90 x 45 F7

4 nails or screws through each side of both bottom chords into lacing at both lacing (16 total)

Connection of Lacing to Bottom Chords

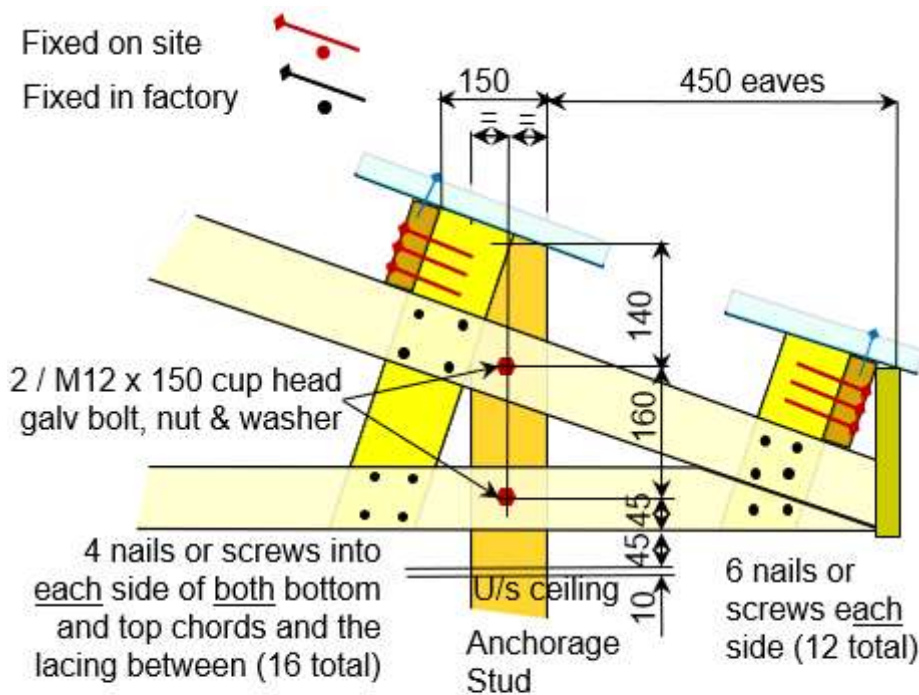

Top Chord to Bottom Chord
Top Chord to Anchorage Stud

450 Eaves

Roof Fixings and Cyclone Washers

Cyclonic wind can suck roof sheeting (and wall sheeting) off the framing if there is an insufficient number of appropriate roofing screws, or if the screws have been installed without cyclone washers.

Roof sheets should be fixed through the high point of the ribs using long screws, not valley fixed. Roof sheets shall be laid in continuous lengths where practical, with the upper end turned up using the correct tool.

In very high wind areas, turn the sheets down into the eaves gutter at the lower end.

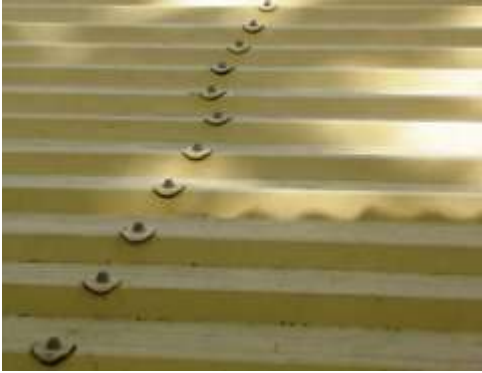

Refer to the Lysaght Design Manual

CUSTOM ORB®/CUSTOM BLUE ORB®



Table 4.2

CUSTOM ORB® 0.42mm BMT.

Span (mm)	Roof			
	Crest fixed	With cyclonic washers		
		3.75kPa	5.58kPa	8.21kPa
450	OK	OK	OK	X
600	OK	OK	OK	X
750	OK	OK	OK	X
900	OK	OK	X	X

End Wall Framing

8.4 clear span building in a non-cyclonic environment (DANCER 8.4)

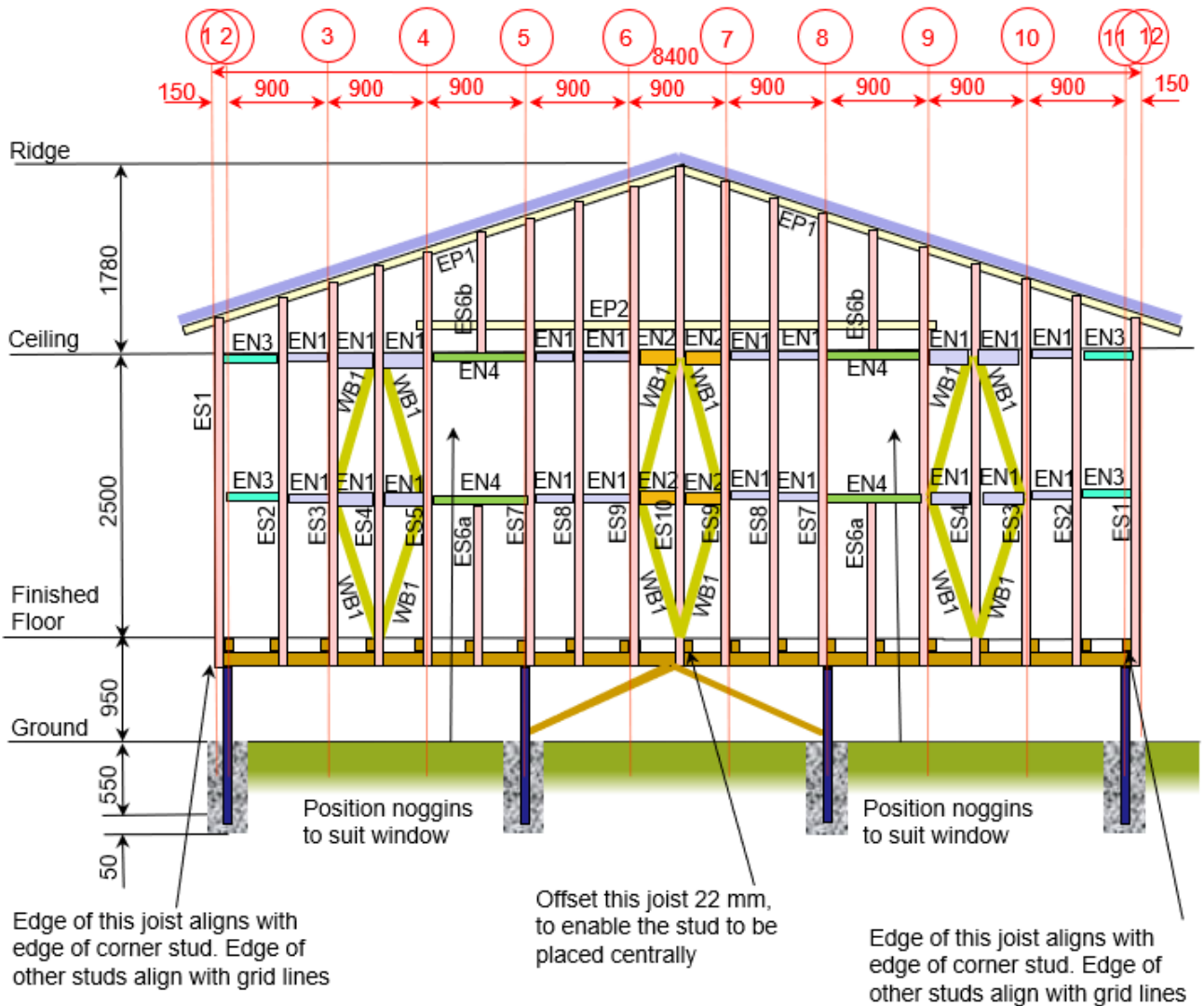

Notch the studs (ES3, ES4, ES5; ES9, ES10, ES9; ES5, ES4, ES3) where the diagonal braces (WB1) cross these studs. Fix nogging (EN1) with 90 dimension vertical here these braced are located.

Section Through Classroom End Walls

8.1 maximum clear span trusses x 5.4 maximum between cross walls

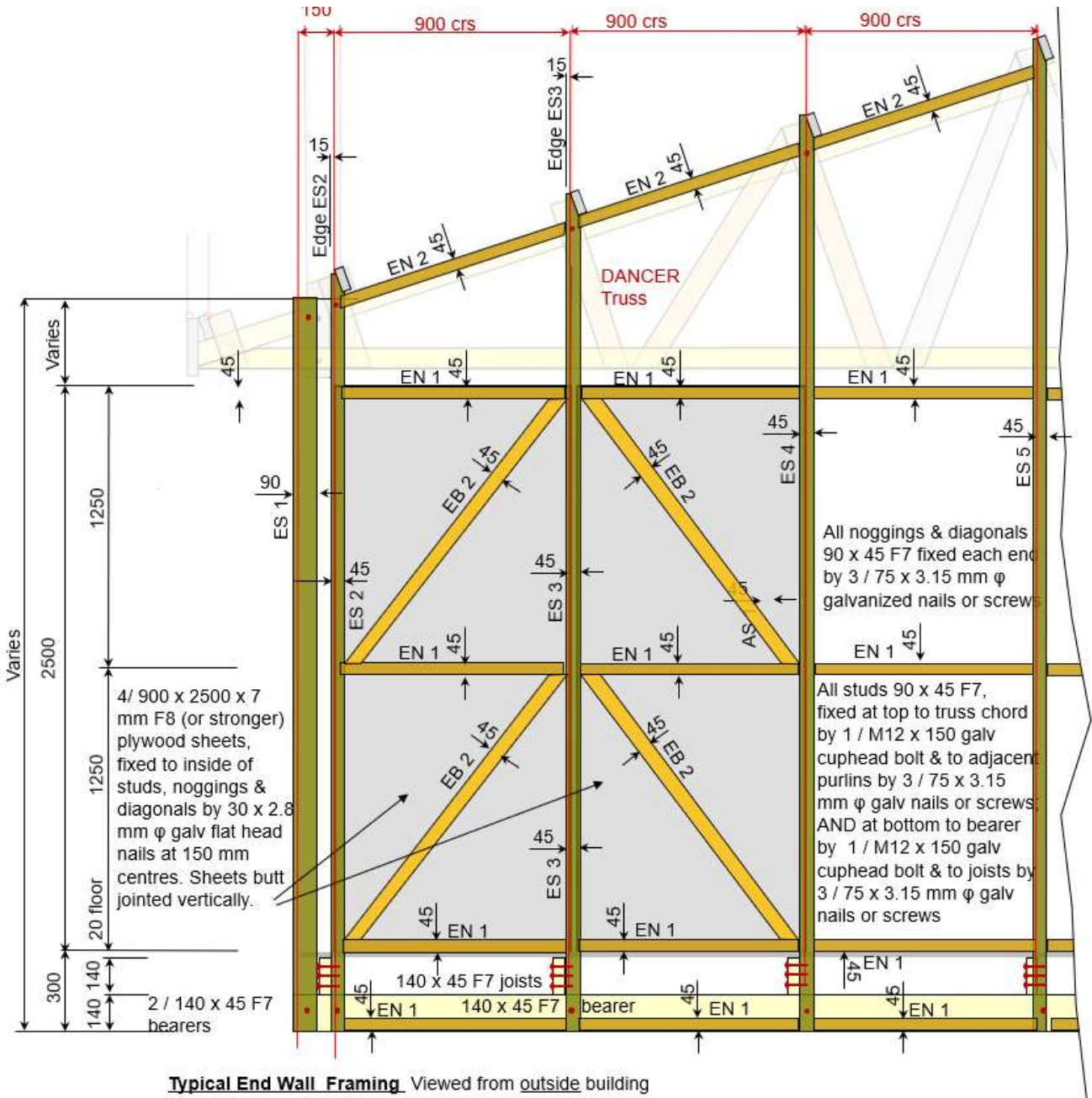

Front Wall Framing

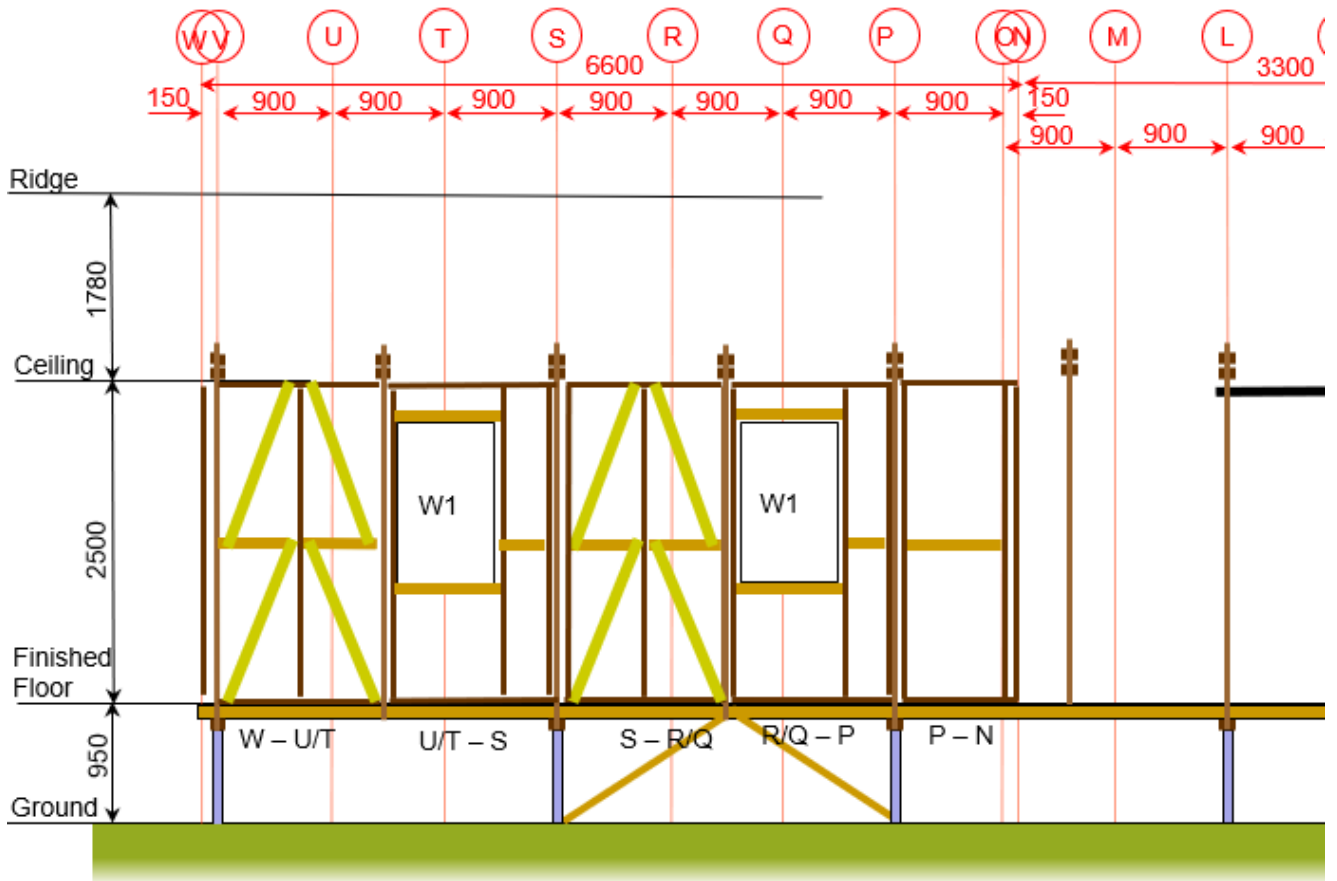

Front Wall Panels Trusses at 1350 centres

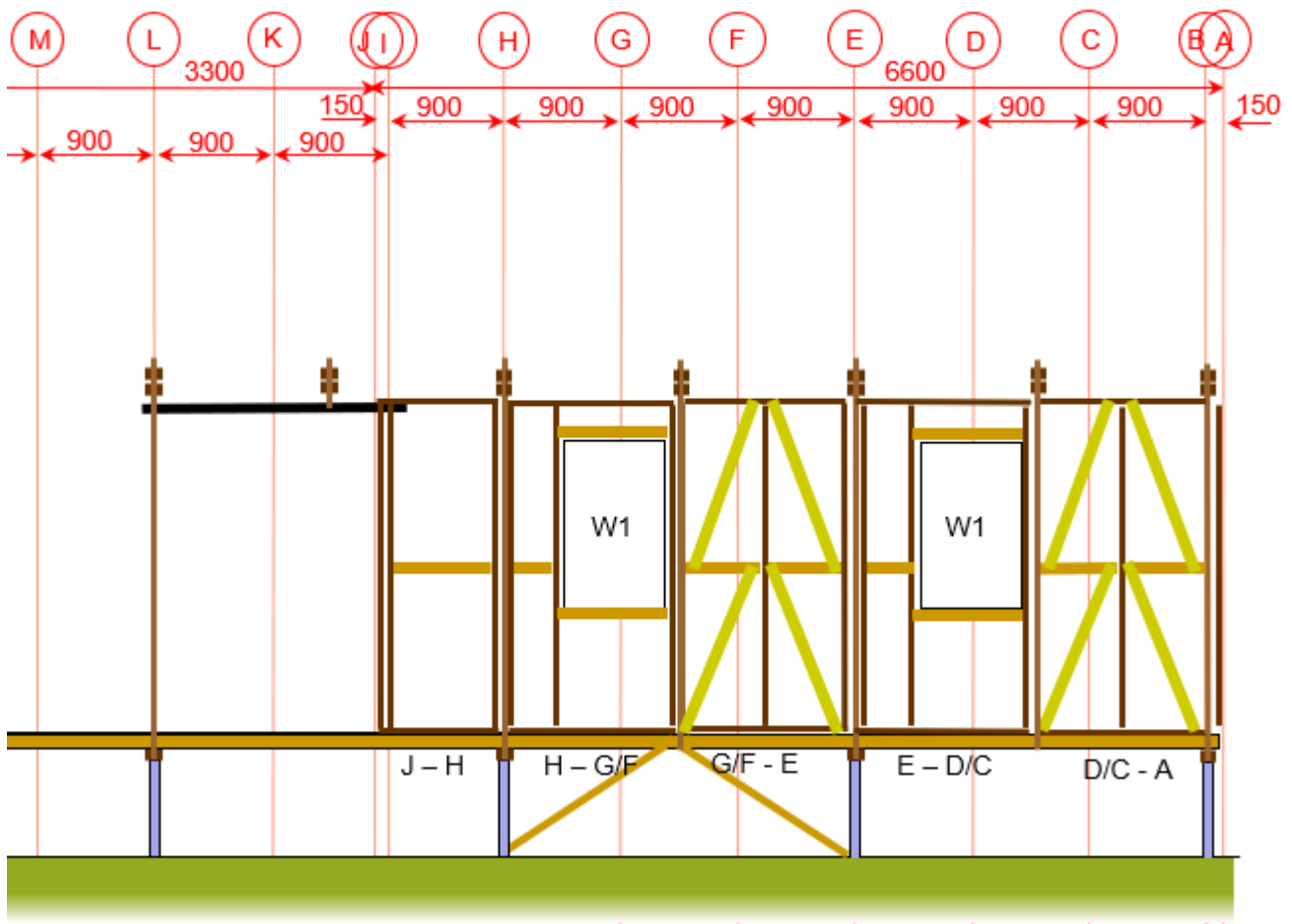

Rear Wall Framing

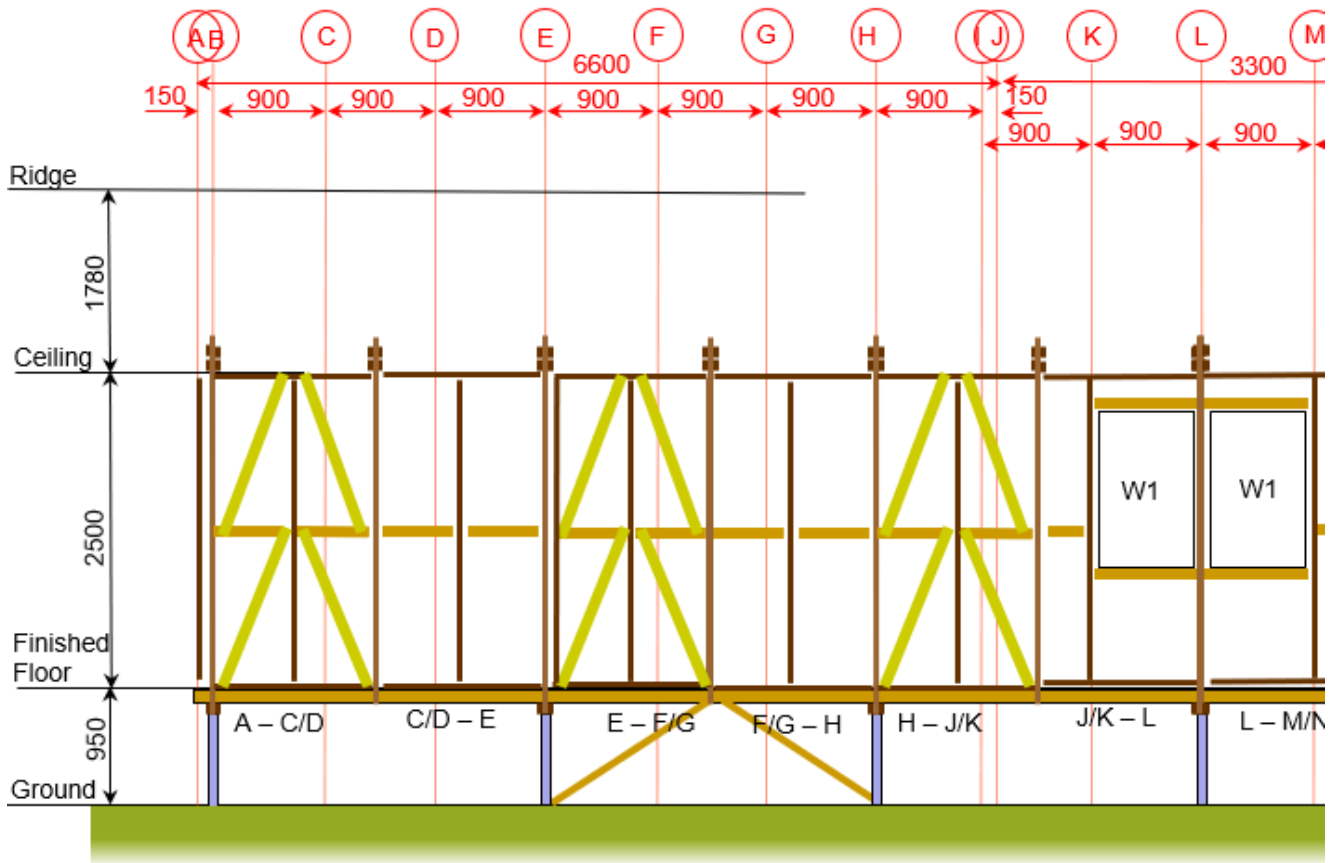

Rear Wall Panels Trusses at 1350 centres

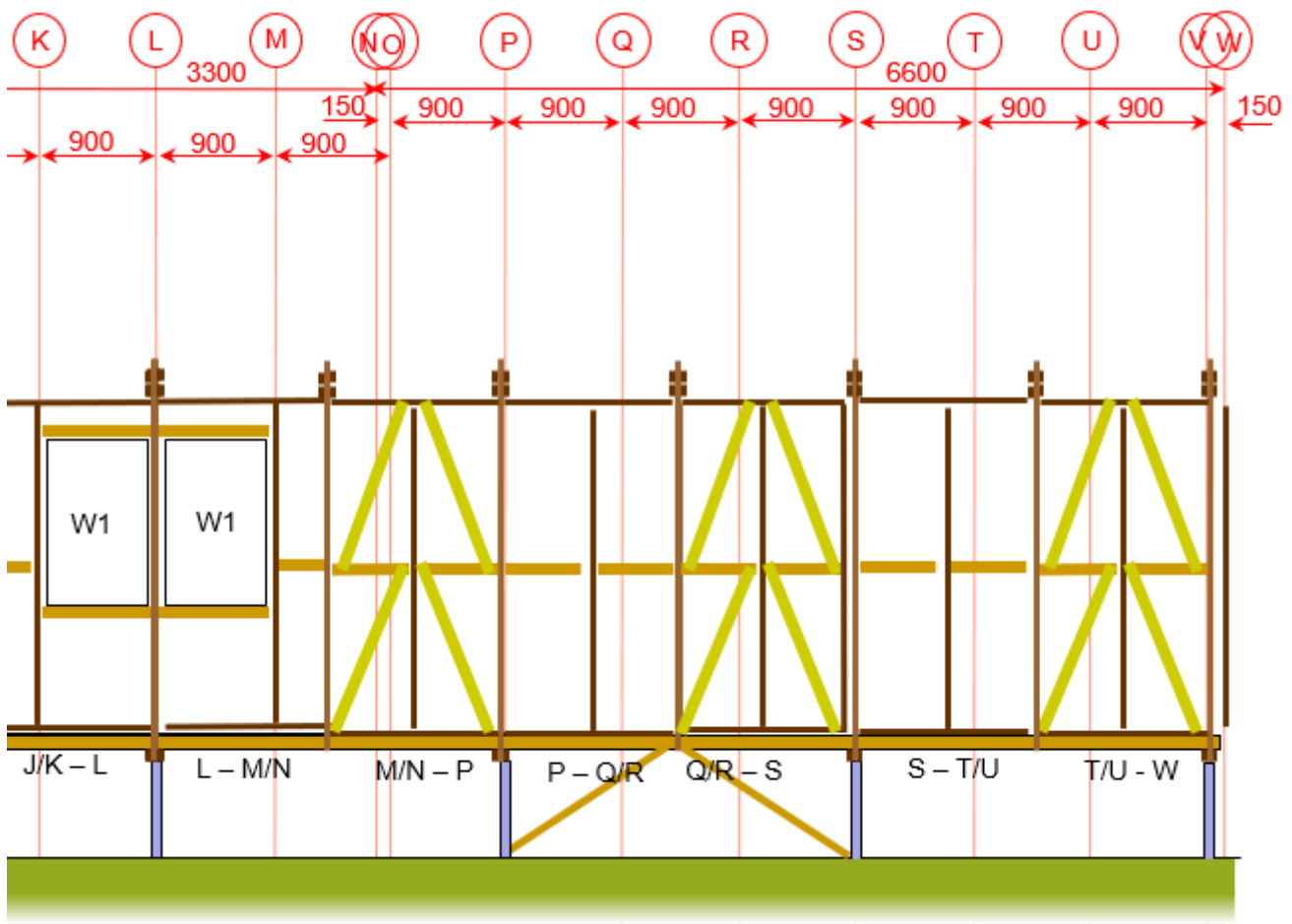

External Wall Frame Details

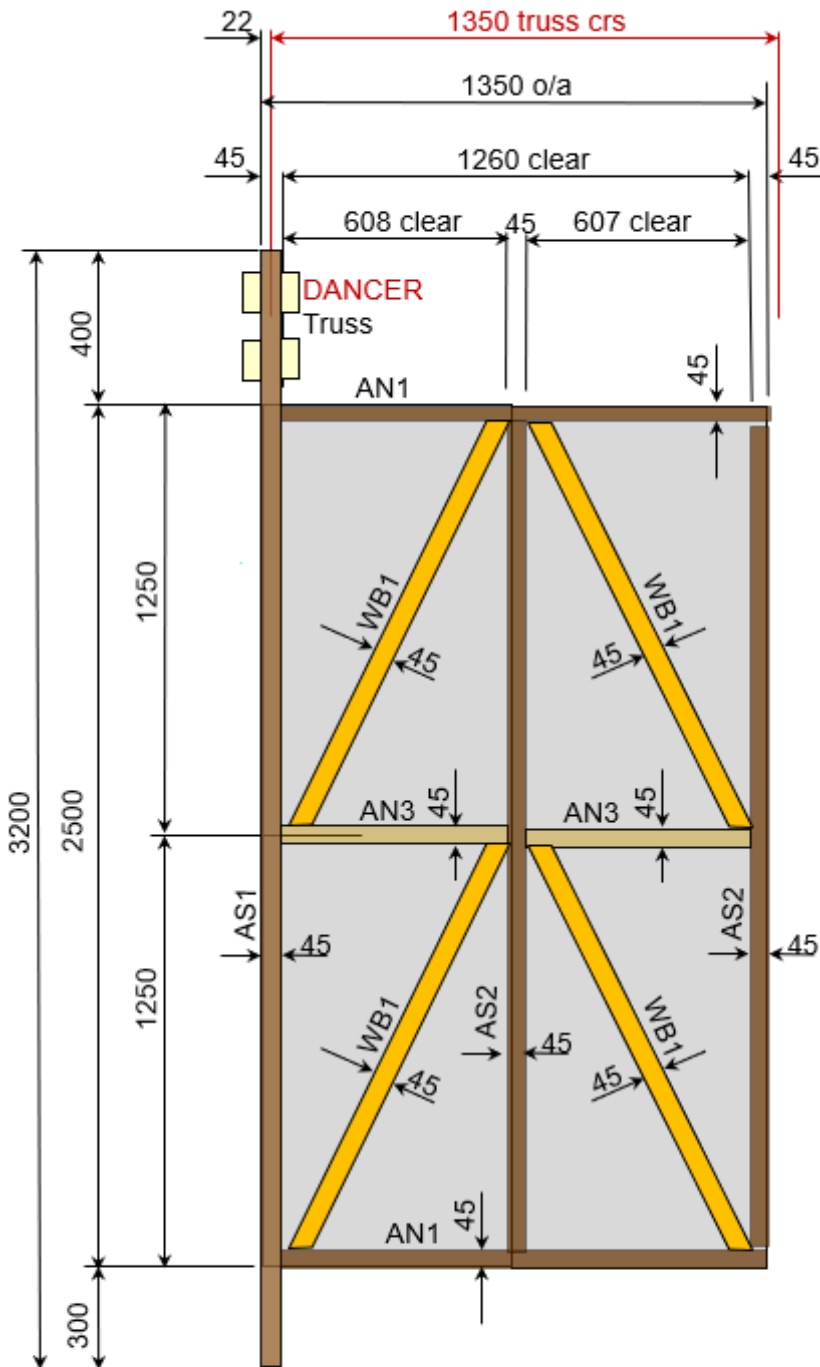

2 / 620 x 2500 x 7 mm F8 (or stronger) plywood, fixed to inside of studs, noggings & diagonals by 30 x 2.8 mm ϕ galvanized flat head nails at 150 mm centres. Sheets butt jointed vertically.

All members, 90 x 45 F7, fixed each end by 3 / 75 x 3.15 mm ϕ galvanized nails or screws

Typical Wall Framing 1350 long with Bracing

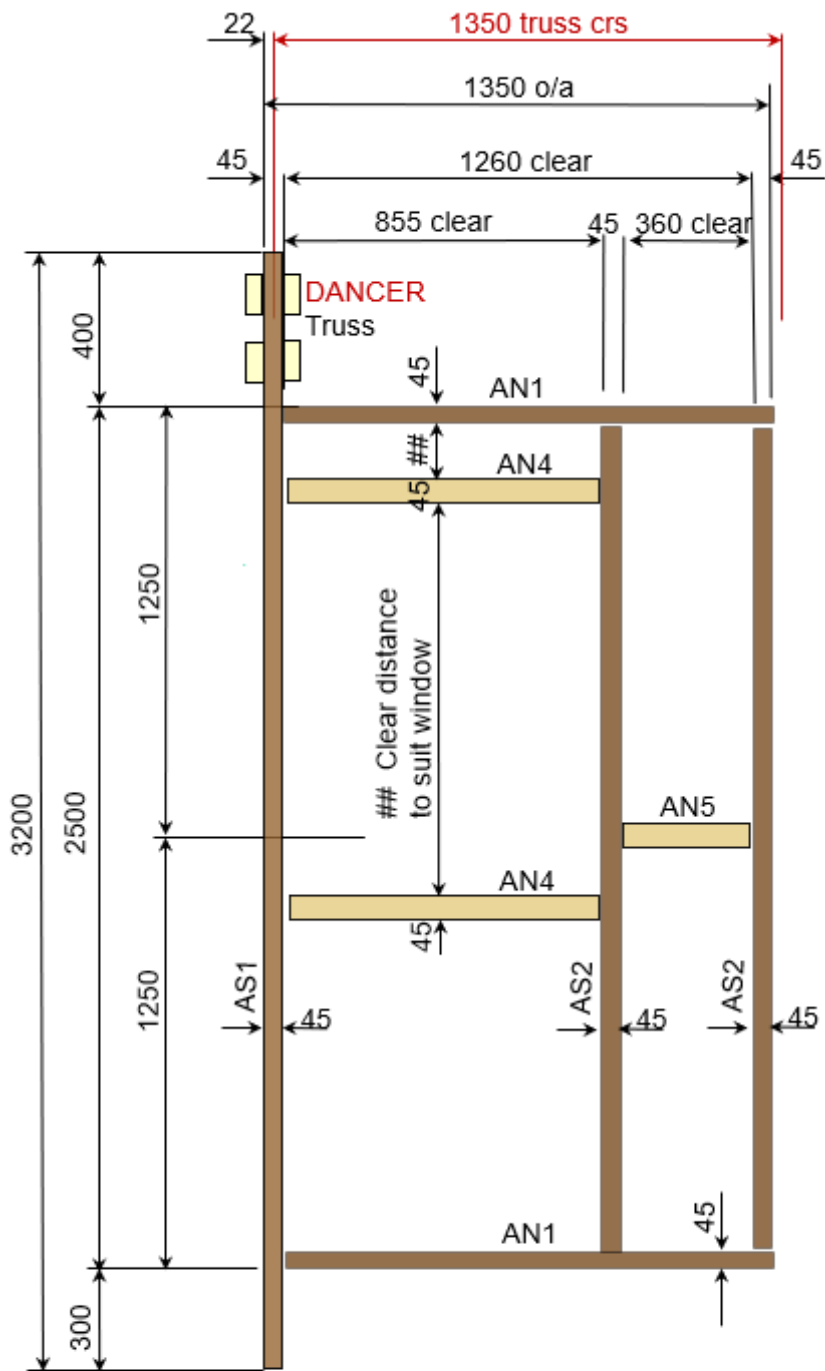

All members, 90 x 45 F7, fixed each end by 3 / 75 x 3.15 mm ϕ galvanized nails or screws

Typical Wall Framing 1350 long with Window

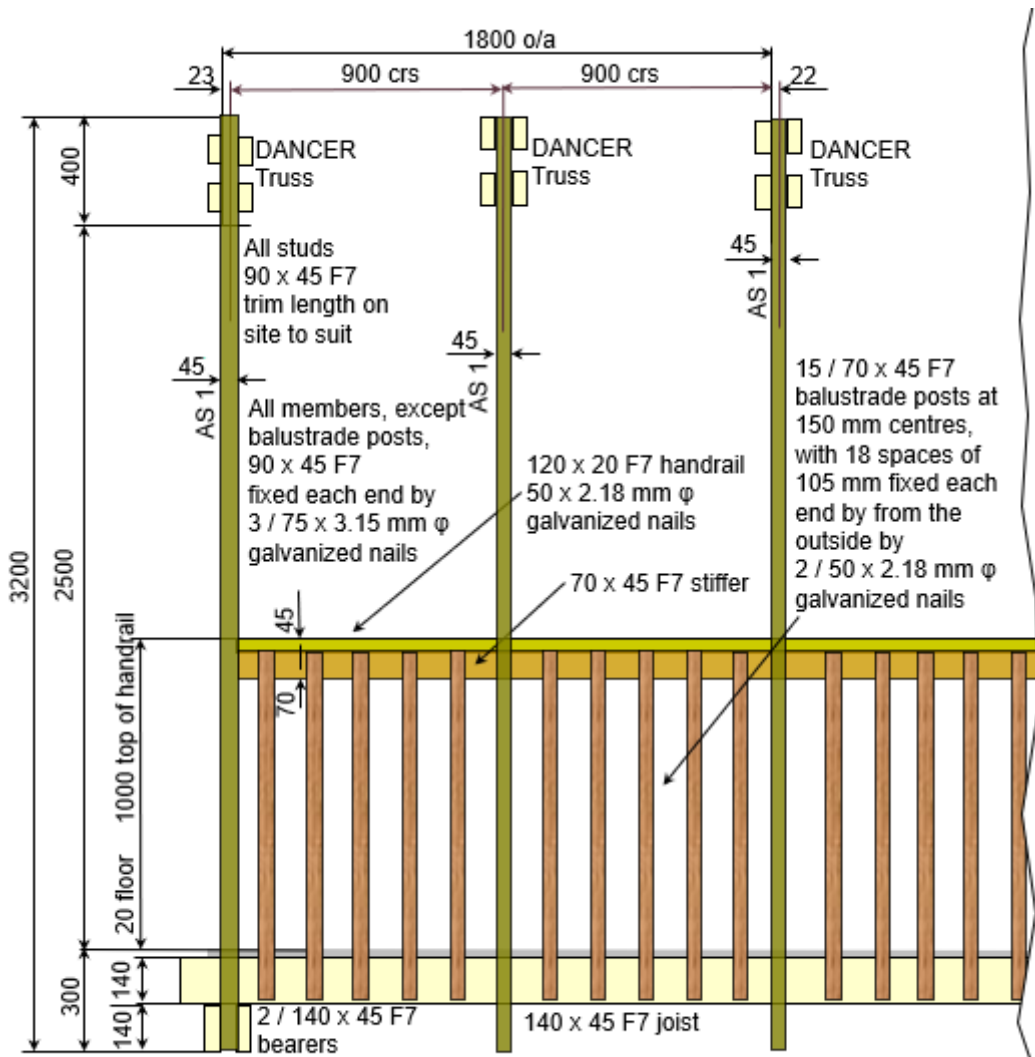

Veranda Wall Framing supporting DANCER Trusses at 900 centres

Bearers, Joists, Floor, Posts and Stud Arrangement

For standards buildings on a 2.700 x 2.700 grid with 0.150 overhangs, the bearer timbers will all be 3,000 long. At an external wall, the bearer is square ended and at internal ends it is tapered.

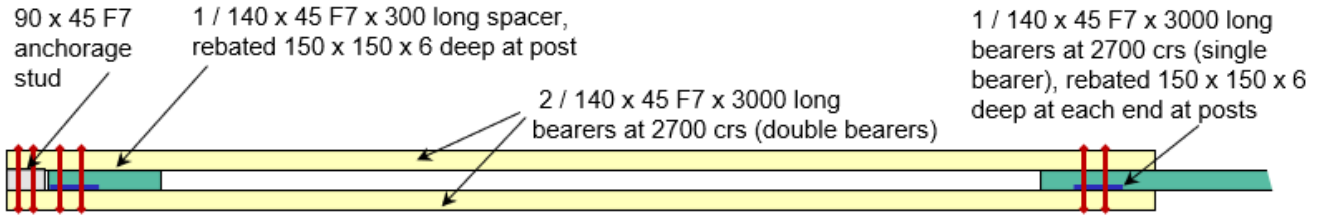

Plan Showing Anchorage Studs, Double & Single Bearers

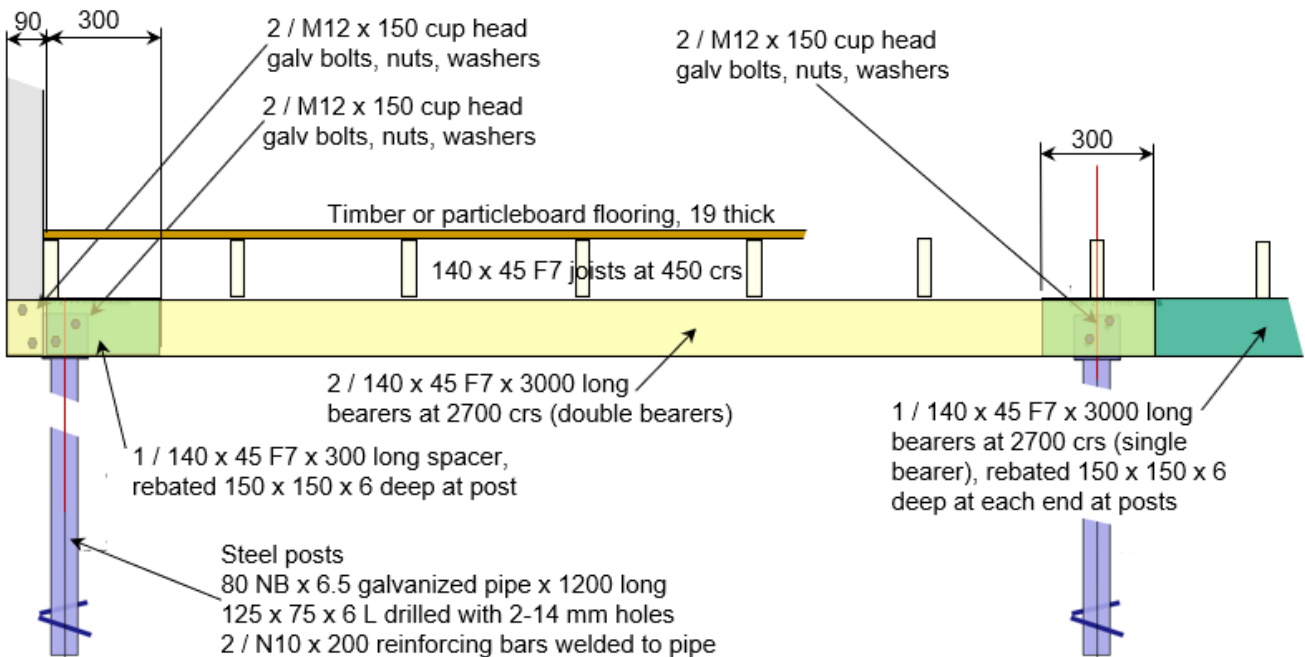

Bearers in external bays are double bearers, bearers in internal bays are single bearers.

Except where specified otherwise in these drawings or specifications, all details shall comply with AS 1684.3

Section Showing Anchorage Studs, Joists, Double & Single Bearers and Posts

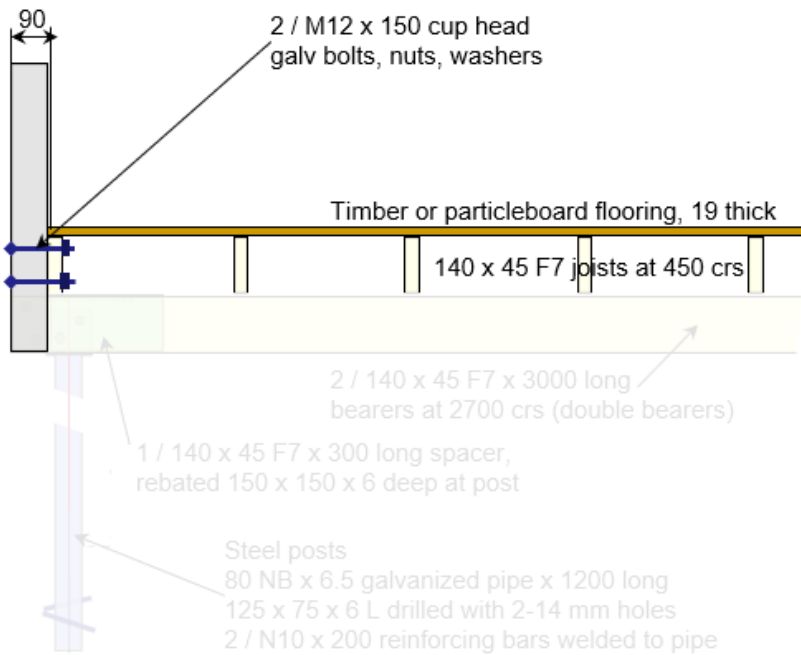

Bearers in external bays are double bearers, bearers in internal bays are single bearers.

Except where specified otherwise in these drawings or specifications, all details shall comply with AS 1684.3

Section Showing Anchorage Studs and Joists where there are no Bearers or Posts

Diagonal Sub-floor Bracing and Steel Posts

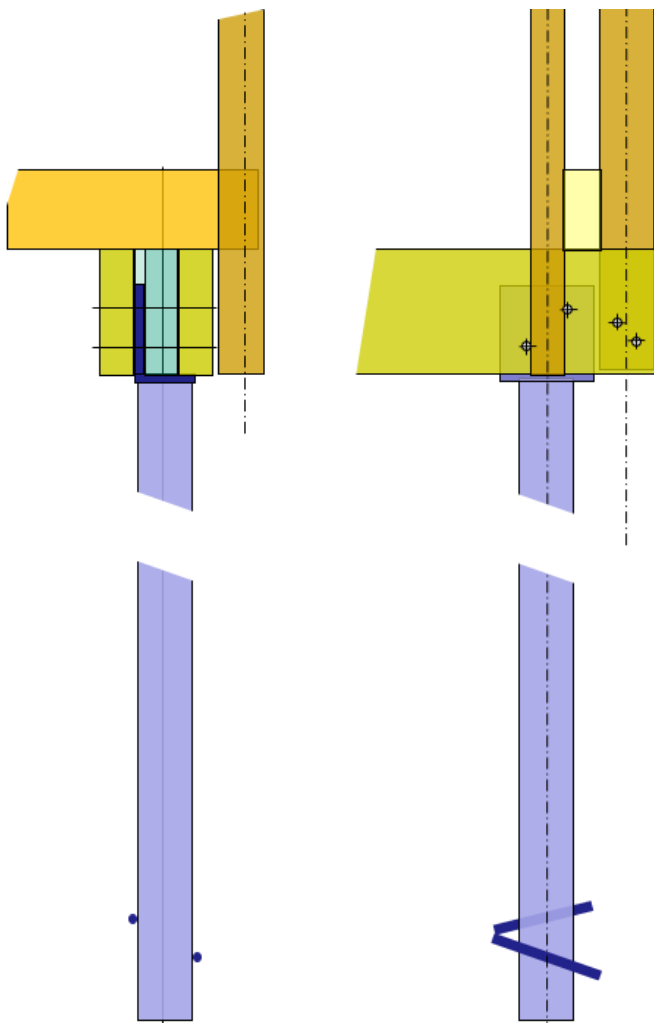
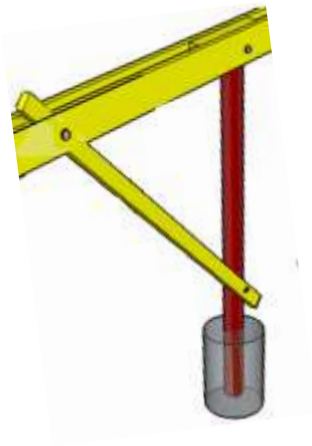

Connections at floor of steel posts with additional cleats

Concrete Piers and Steel Posts

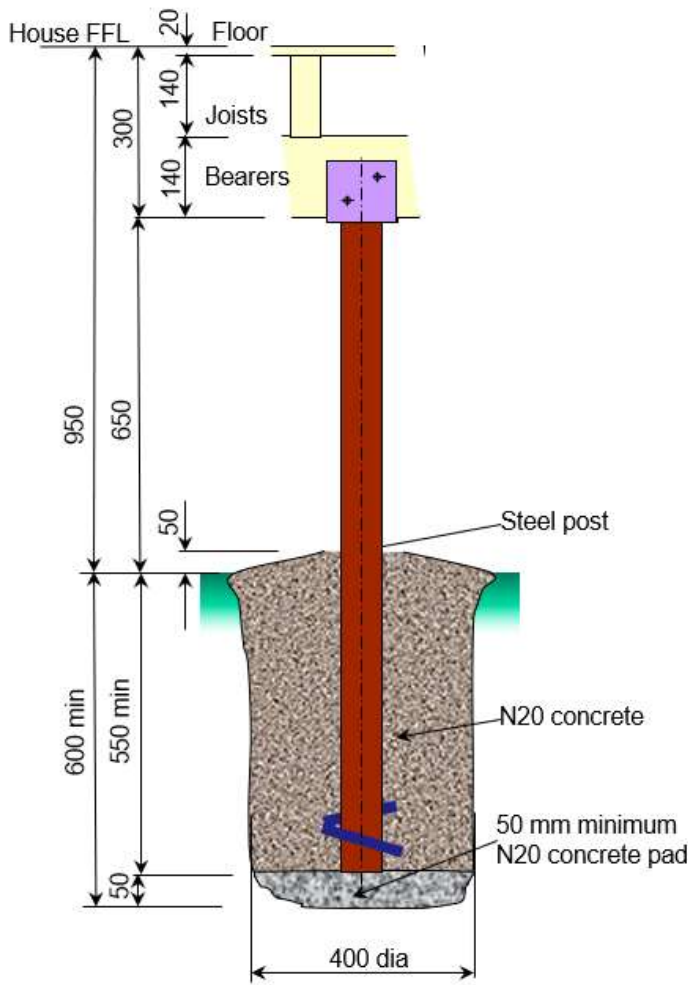

Concrete Pier, Steel Posts and Timber Floor

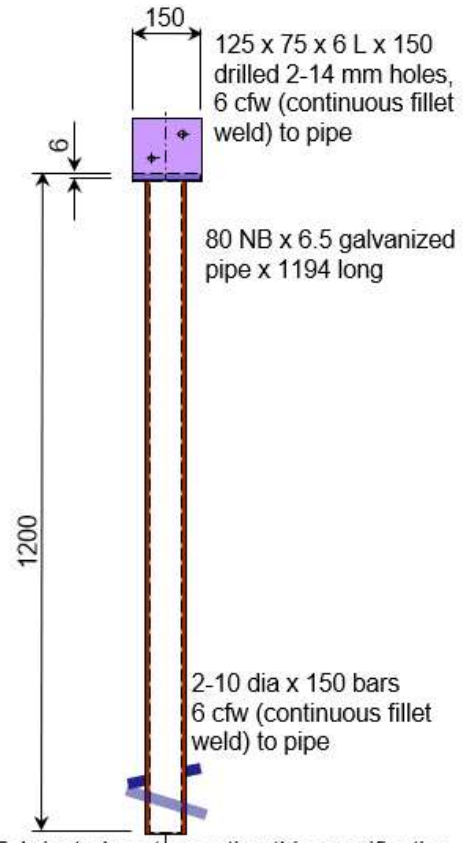

Fabricated posts meeting this specification (or similar) may be available from hardware retailers. If the length of the post is different, the height of the finished floor level and the details of the steps may need to be adjusted.

Steel Posts

Plan of Corner Showing Bearer, Joist, Post and Studs

The following plan views show the relative positions of the double bearer (including the spacer), edge joist, steel post, anchorage stud and corner stud. The outside vertical face of the steel angle must be offset 20 mm from the gridline and **must be on the same side for every post**. If this is not done, prefabricated wall framing will not fit properly. The spacer timbers at the posts (shown in green) must be rebated 6 mm for a 150 mm length, to fit past the steel section. The plan (for 90 x 35 dressed timber) below is typical of the arrangement.

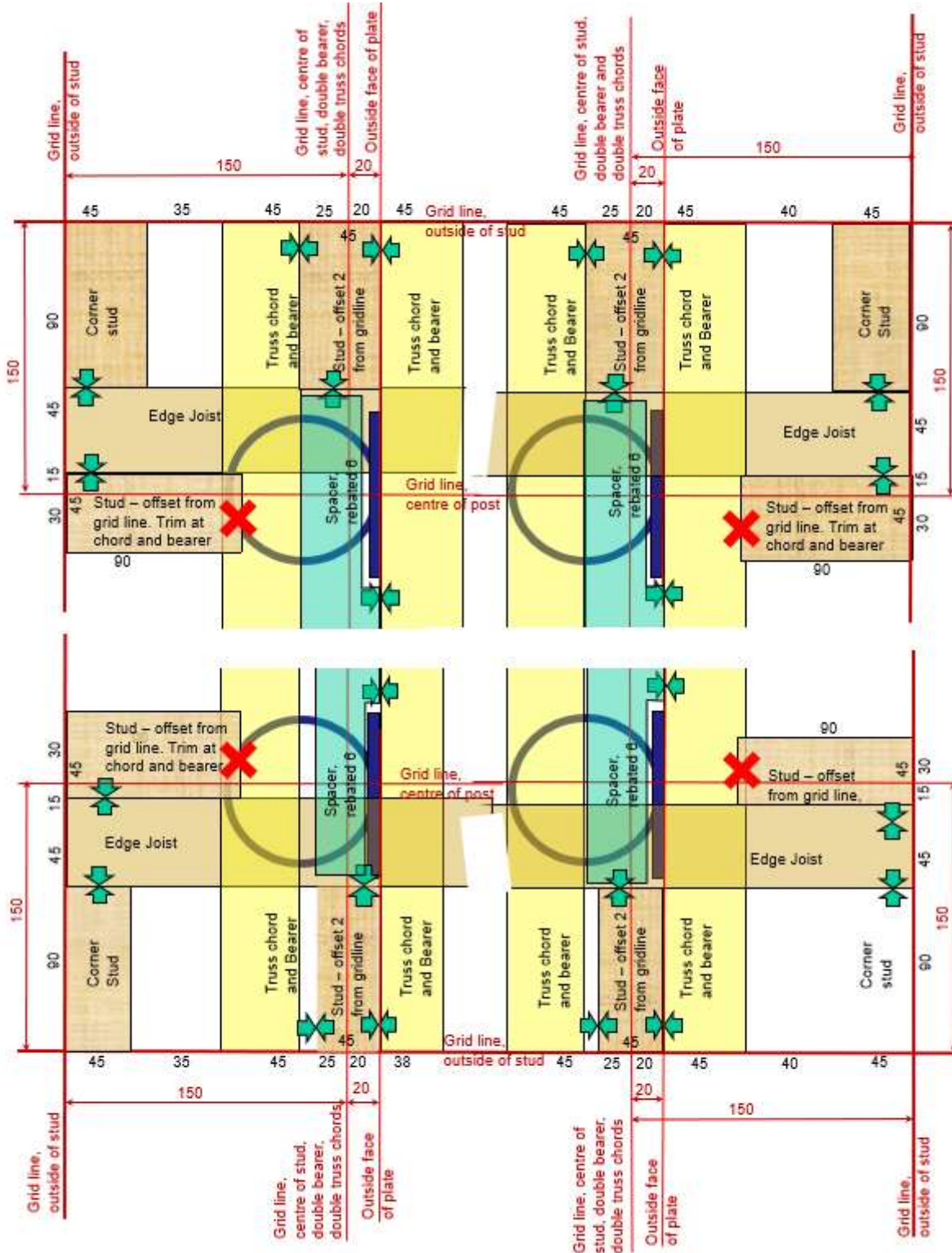

Arrangement at the Corner of Building for 90 x 45 studs and 140 x 45 bearers

Gridlines and Steel Post orientation

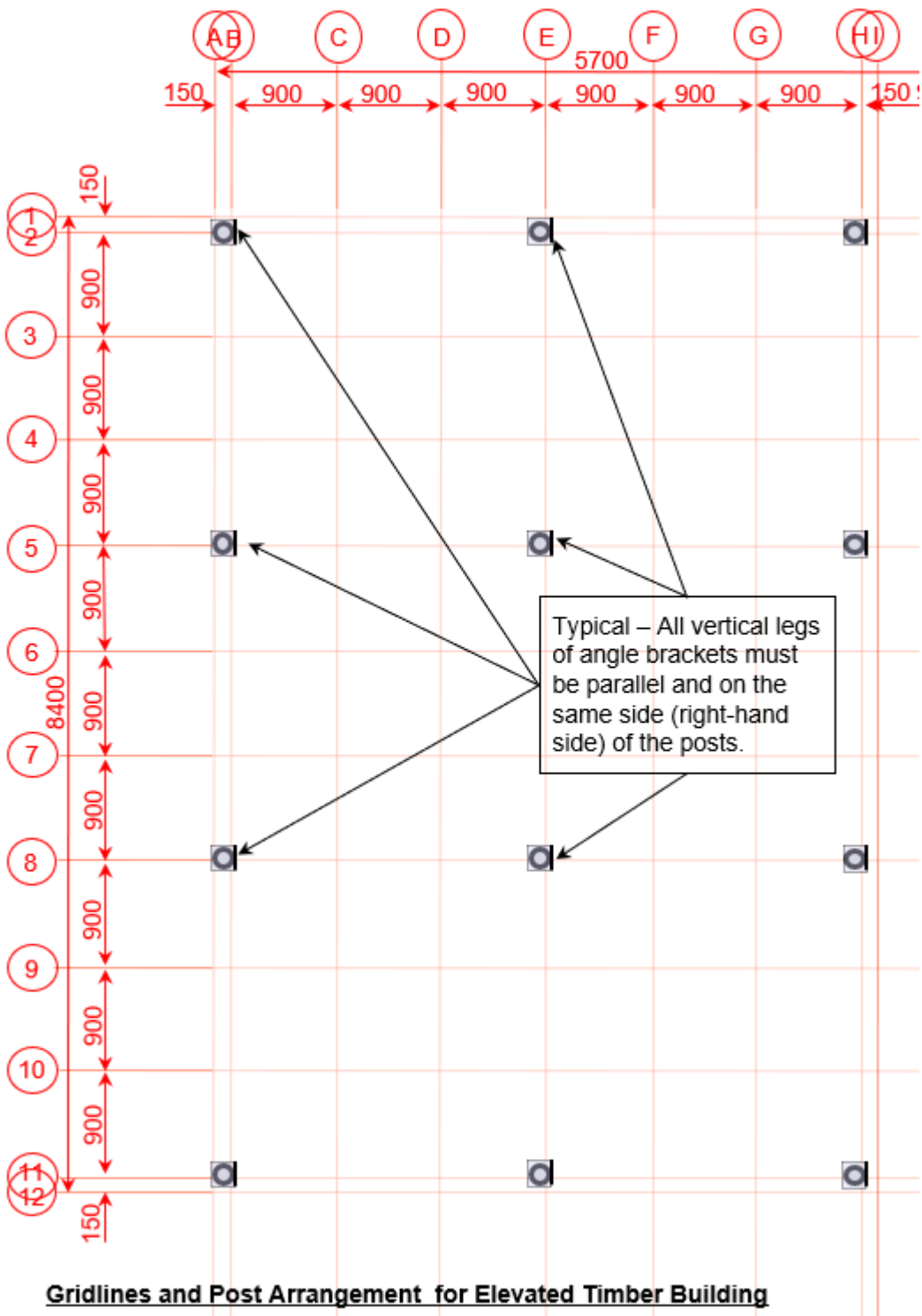

Stairs

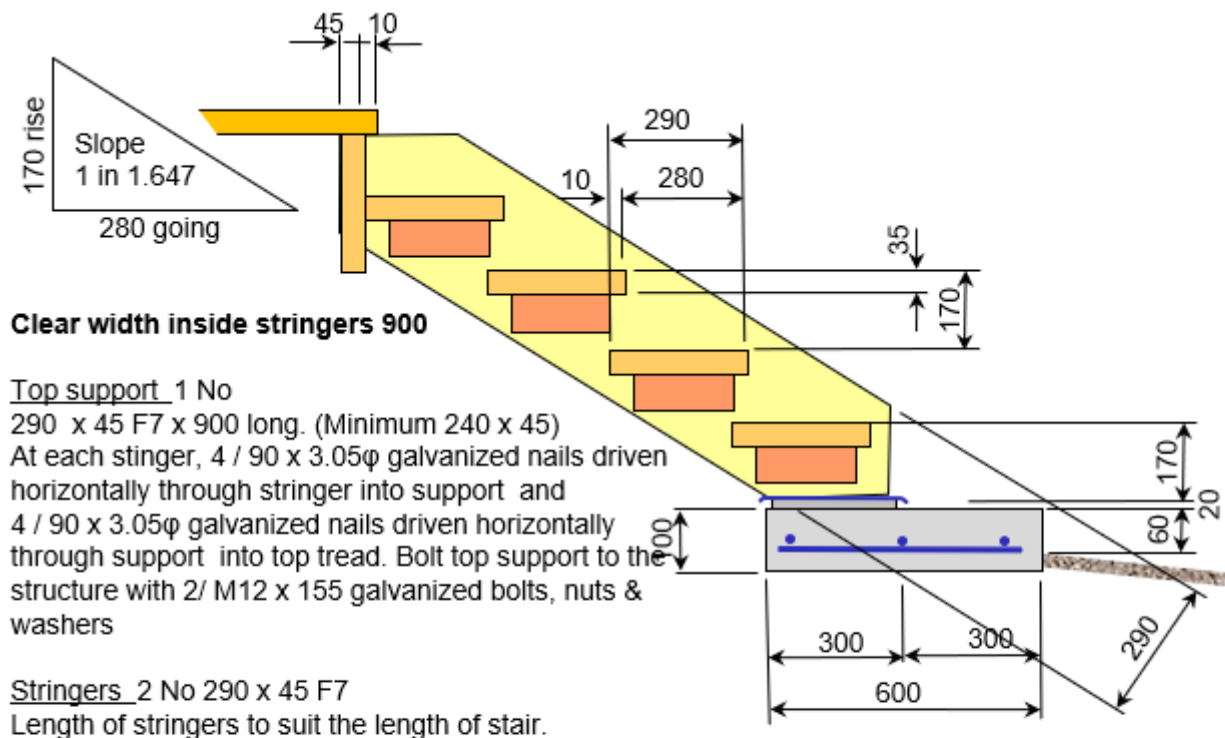

Treads – Number of treads to suit length of stair
290 x 45 F7 x 920 long. Slot the treads into rebates, 10 mm deep in the stringers to give 900 clear width.
At each stinger, 2 / 90 x 3.05φ galvanized nails driven horizontally through stringer into tread and 2 / 90 x 3.05φ galvanized nails driven vertically through stringer into support

Tread supports –
2 per tread. 90 x 45 F7 x 260 long
3 / 90 x 3.05φ galvanized nails driven horizontally through support into stringer

Termite shield – 2 / 100 x 3 x 350 galvanized steel strips, folded down 20 mm around edges, nailed to the underside of the stair stringer and kept clear of debris.

Stair Dimensions				
Stair going	280	mm		
Stair rise	170	mm		
Grout thickness	0	mm		
Height of slab above ground	80	mm		
No of Rises	No of Goings	Stair Rise	Stair Going	Veranda Height
5	4	850	1120	930

Concrete Pad – 1,200 x 600 x 100 mm thick
5 / N10 x 550 reinforcing bars and
3 / N10 x 1150 reinforcing bars
Top surface of slab nominally 60 mm above ground level. If the slab surface is low, grout (up to a maximum thickness of 20 mm) under both stringers to make up required height. If the slab surface is high, trim the bottom surface of the stringers.

Section Through Timber Stairs

Stair Balustrades

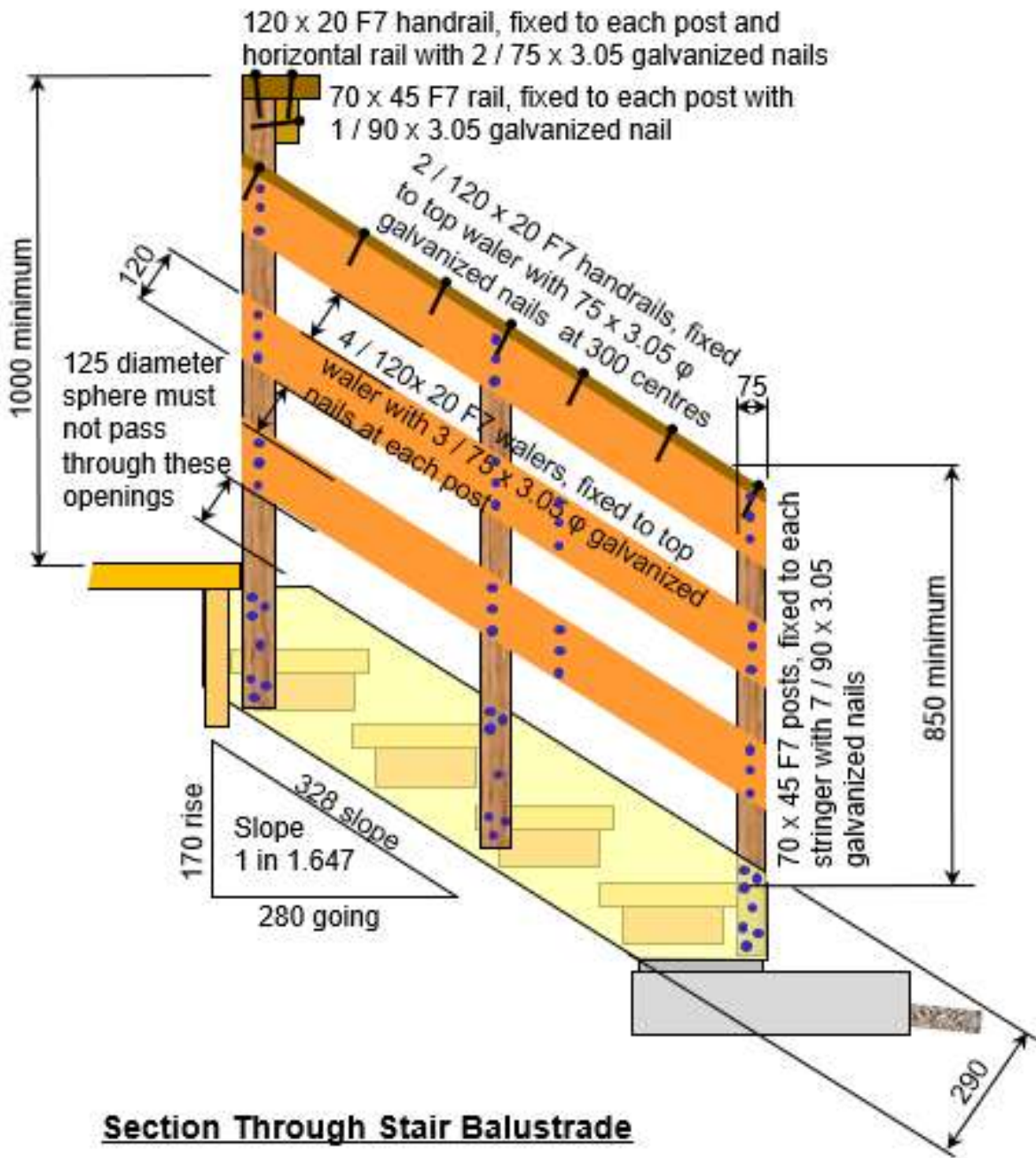

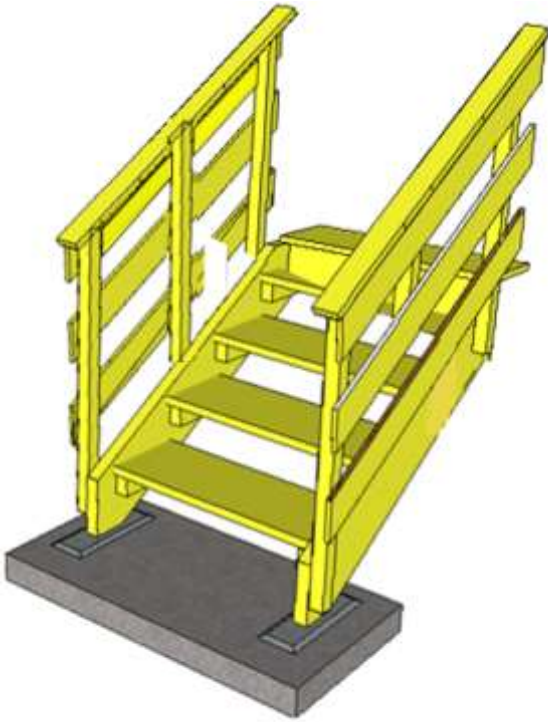

Typical Timber Stairs – 5 Rises

Veranda Balustrades

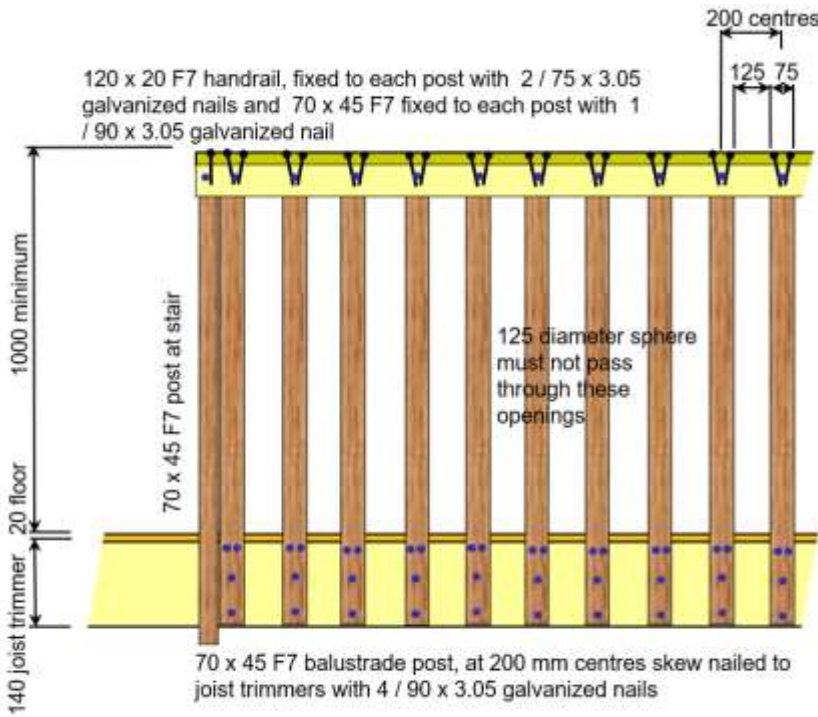

Elevation of typical Veranda Balustrade

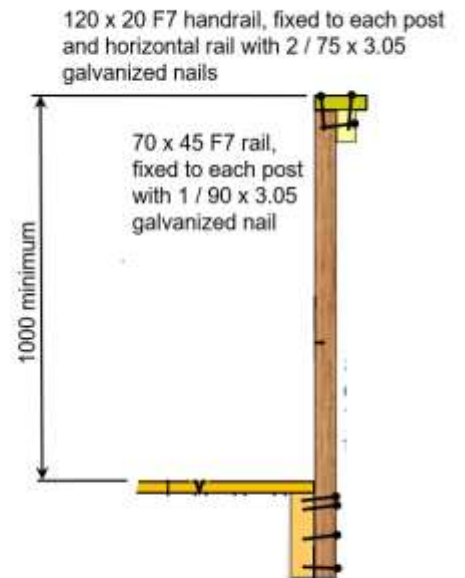

Section through Veranda Balustrade

Window Shades

All timber members 90 x 45 F7,
 fixed at each end by – Nailed or screwed on site
 4 / 90 x 3.45 φ screws, or Nailed or screwed in factory
 4 / 90 x 3.75 φ nails

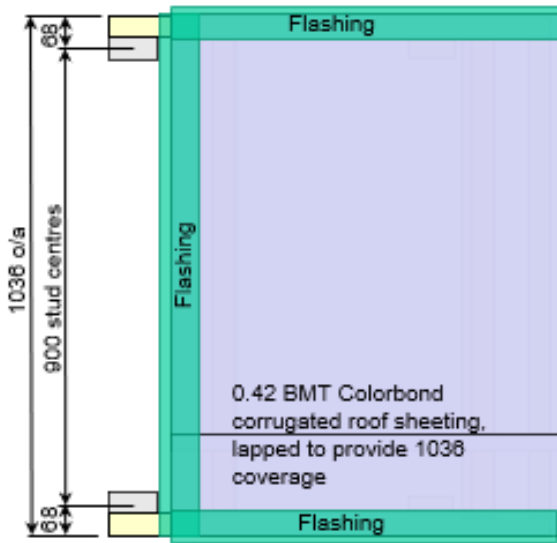

Plan of Window Shade

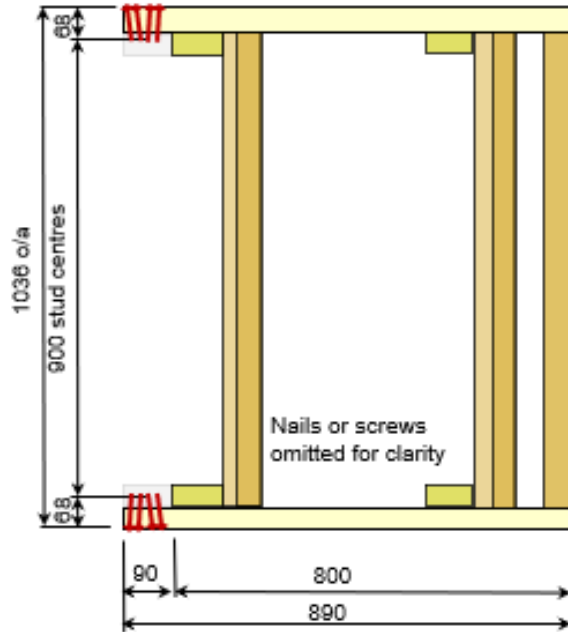

Plan of Window Shade Frame

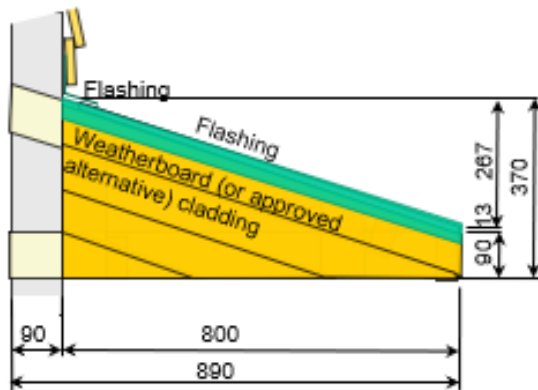

Elevation of Window Shade

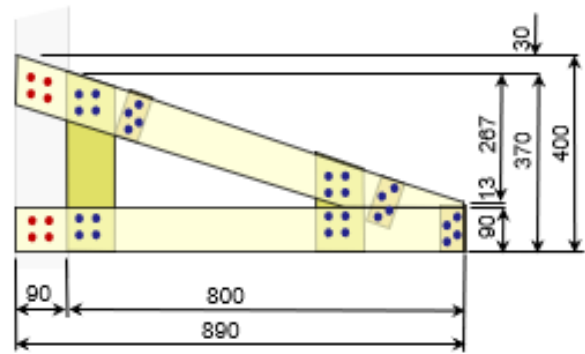

Elevation of Window Shade Frame

Concrete Mix for Piers and Footings

20 MPa mix (by volume) 1 : 2 : 4		
Volume of concrete	m ³	1.0
Wastage included	%	
GP or GB cement	40 kg bags	8
Clean sharp sand	m ³	0.5
20 mm rock aggregate	m ³	1.0

**For 1 cubic metre (1 m³)
of 20 MPa concrete**



Cement 8 – 40 kg bags



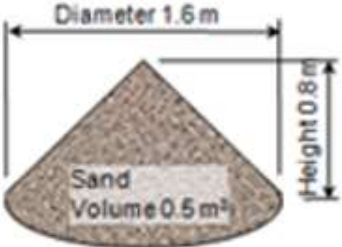



Sand
Volume 0.5 m³

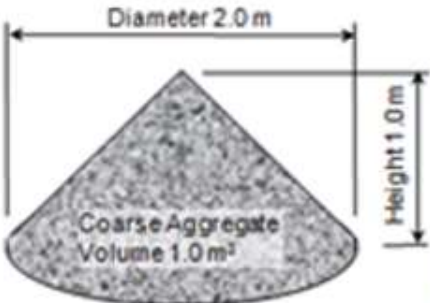



Coarse Aggregate
Volume 1.0 m³





Water 11 – 20 litre buckets



Details requiring special monitoring

The following fabrication errors details have been the source of deviations from the design drawings on previous projects, and require monitoring to ensure that these deviation do not occur again.

1. Replace the splayed splice with a double/ single bearer splice.

This has already been agreed and detailed in the latest version of the design file.

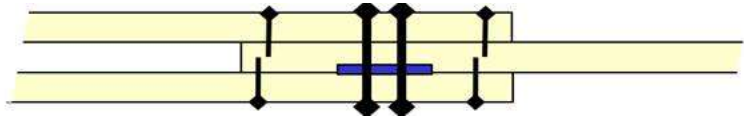

2. Use a spacer rebate not more than 6 mm in thickness

The 90 x 45 mm spacer is required to be rebated 6 mm timber at the steel cleat, to achieve the correct spacing between the double bearers. However, if the rebate is too deep, the bearers will be too close together (as is the case in this photo) requiring the studs to be rebated. The depth of the spacer rebate must be limited to no more than 6 mm. A standard detail will be provided.



3. Fix the end wall studs into one of the double bearers by two M12 x 150 cuphead galvanized bolts through the stud.

Also fix the stud to the joist by three screws. A standard detail will be provided.



4. **Do not cut diagonal bracing.**

Where an internal wall meets the external wall, it does not require an extra stud in the external wall. The end stud of the internal wall may be flush with the inside face of the external wall. A standard detail will be provided.



5. **Support the ceiling battens from the bottom chord of the trusses.**

This will reduce the number of separate ceiling supports required.



6. **End eaves are not required**

The standard community health building design does not include end wall gables. This is intentional, because it reduces the area (and cost) of the roof sheeting. It also enables the standardisation of the roof purlins. If the building requires end wall gables, this will require a redesign and budget increase.



7. **Additional joists under internal walls should be determined on site rather in standard designs**

The location should be determined on site.

Cutting Lists

Floor		Material List						Cutting Schedule		
Item	Component	Section			Material	Quantity		No	@	Length
		mm	x	mm		x	m			mm
FB	Floor Bearer	140	x	45	F7	x	115.5	35	@	3,000
FBS	Floor Bearer Spacer	140	x	45	F7	x	9.2	28	@	300
FJ	Floor Joist	140	x	45	F7	x	396.0	120	@	3,000
FT	Floor Trimmer Joist	140	x	45	F7	x	36.3	8	@	4,125

Roof Trusses		Material List						Cutting Schedule		
Roof Trusses										8,400
Item	Component	Section			Material	Quantity		No	@	Length
		mm	x	mm		x	m			mm
TC(L)	Truss Top Chord (or R)	90	x	45	F7	x	143.9	26	@	5,030
TC(S)	Truss Top Chord (or R)	90	x	45	F7	x	139.1	26	@	4,865
BC(L)	Truss Bottom Chord (C)	90	x	45	F7	x	136.3	26	@	4,765
BC(S)	Truss Bottom Chord (C)	90	x	45	F7	x	127.7	26	@	4,465
CT	Collar Tie	90	x	45	F7	x	34.3	26	@	1,200
KP	King Post	90	x	45	F7	x	24.8	13	@	1,735
L1	Lacing at eaves	90	x	45	F7	x	7.1	26	@	248
L2	Lacing at anchorage st	90	x	45	F7	x	11.9	26	@	416
L3	Lacing	90	x	45	F7	x	21.0	26	@	734
L4	Lacing	90	x	45	F7	x	30.0	26	@	1,050
L5	Lacing	90	x	45	F7	x	39.1	26	@	1,366
L6	Lacing	90	x	45	F7	x	21.7	26	@	760
D1	Diagonal	90	x	45	F7	x	32.0	26	@	1,118
D2	Diagonal	90	x	45	F7	x	39.6	26	@	1,385
D3	Diagonal	90	x	45	F7	x	50.4	26	@	1,762
	Roof trusses	90	x	45	F7		858.9	377		

Purlins, Veranda, Fascias, Barge Boards		Material List						Cutting Schedule		
Item	Component	Section			Material	Quantity		No	@	Length
		mm	x	mm		x	m			mm
CJ	Ceiling Joist (additional)	45	x	90	F7	x	60.7	14	@	3,000
CBa	Ceiling Batten	45	x	90	F7	x	324.0	120	@	2,700
VRa	Veranda Rafter	90	x	45	F7	x	0.0	0	@	0
VBe	Veranda Beam	140	x	45	F7	x	0.0	0	@	1,300
RDB	Roof Bracing	25	x	1	Steel	x	30.1	4	@	6,841
FaB	Fascia Board	240	x	35	F7	x	36.3	8	@	4,125
BaB	Barge Board	240	x	35	F7	x	21.6	4	@	4,902
RPu	Roof Purlin	90	x	45	F7	x	237.6	72	@	3,000

Walls		Material List						Cutting Schedule		
Item	Component	Section			Material	Quantity		No	@	Length mm
		mm	x	mm		x	m			
External Anchorage Walls										
AS1	Anchorage Stud	90	x	45	F7	x	137.3	39	@	3,200
AS2	External Stud	90	x	45	F7	x	127.2	48	@	2,410
AT1	Anchor Tie	90	x	45	F7	x	36.0	26	@	1,260
AN1	Anchorage Nogging	90	x	45	F7	x	66.5	48	@	1,260
AN2	Anchorage Nogging	90	x	45	F7	x	5.7	4	@	1,305
AN3	Anchorage Nogging	90	x	45	F7	x	16.1	24	@	607
AN4	Anchorage Nogging	90	x	45	F7	x	22.5	24	@	855
AN5	Anchorage Nogging	90	x	45	F7	x	3.9	10	@	360
AN6	Anchorage Nogging	90	x	45	F7	x	0.9	2	@	405
WB1	Wall Brace	90	x	45	F7	x	73.7	48	@	1,390
External End Walls										
ES1	End Stud	90	x	45	F7	x	7.0	2	@	3,200
ES2	End Stud	90	x	45	F7	x	7.4	2	@	3,360
ES3	End Stud	90	x	45	F7	x	8.3	2	@	3,760
ES4	End Stud	90	x	45	F7	x	9.2	2	@	4,160
ES5	End Stud	90	x	45	F7	x	9.1	2	@	4,560
ES6	End Stud	90	x	45	F7	x	9.1	2	@	4,560
ES7	End Stud	90	x	45	F7	x	8.3	2	@	4,160
ES8	End Stud	90	x	45	F7	x	7.5	2	@	3,760
ES9	End Stud	90	x	45	F7	x	7.5	2	@	3,760
ES10	End Stud	90	x	45	F7	x	7.2	2	@	3,600
EN1	End Nogging	90	x	45	F7	x	52.7	56	@	855
EN2	End Nogging (corner)	90	x	45	F7	x	58.3	56	@	946
EN3	End Nogging (centre)	90	x	45	F7	x	29.0	10	@	2,640

EP1		0		0			0.0	0		0
VP	Veranda Post	0		0		x	0.0	0	@	0
Internal Walls										
CS 2	Common Stud	90	x	45	F7	x	265.8	100	@	2,410
BP	Wall Bottom Plate	45	x	90	F7	x	109.6	20	@	5,400
TP	Wall Top Plate	45	x	90	F7	x	219.1	41	@	5,400
NG	Wall Nogging	90	x	45	F7	x	109.6	20	@	5,400
DB	Extra Diagonal Wall Br	30	x	1	Steel	x	13.8	8	@	1,570
LI	Lintel	90	x	45	F7	x	14.9	3	@	5,400
	Studs, Plates, Nogging	90	x	45	F7	x	1,463.0	611	@	
WB	Wall Bracing (First Sto	Input	mm		External plywood			Plywood		2,500

Stairs, Balustrade, Seats								Cutting Schedule		
Item	Component	Section			Material	Quantity		No	@	Length mm
		mm	x	mm		x	m			
SSt	Stair Stringer	290	x	45	F7	x	3.5	2	@	1,586
STr	Stair Tread	290	x	45	F7	x	8.0	4	@	1,820
STS	Tread support	70	x	45	F7	x	2.3	8	@	260
SSS	Stair stringer support	290	x	45	F7	x	2.0	1	@	1,820
SPo	Stair post	90	x	45	F7	x	6.4	6	@	975
SMR	Stair wales	120	x	20	F7	x	10.5	6	@	1,586
SHR	Stair hand rail	120	x	20	F7	x	3.5	2	@	1,586
VBP	Veranda Balustrade Post	90	x	45	F7	x	0.0	0	@	1,120
FVB	Front Veranda Balustrade	120	x	20	F7	x	5.9	2	@	2,700
FVB	Front Veranda Balustrade	120	x	20	F7	x	2.6	1	@	2,400
BVB	Back Veranda Balustrade	120	x	20	F7	x	0.0	0	@	0
BVB	Back Veranda Balustrade	120	x	20	F7	x	0.0	0	@	0
FVS	Front Veranda Stinger	70	x	45	F7	x	5.9	2	@	2,700
FVS	Front Veranda Stinger	70	x	45	F7	x	2.6	1	@	2,400
SeS	Seat & Stingers	0	x	0		x	0.0	0	@	2,400
BVS	Seat support	0	x	0		x	0.0	0	@	420
BVS	Seat leg	0	x	0		x	0.0	0	@	310

Steel Posts								Cutting Schedule		
Item	Component	Section			Material	Quantity		No	@	Length mm
		mm	x	mm		x	m			
SP1	Steel Post	80 NB			galv med wall pipe		33.6	28	@	1,200
SP2	Steel support angle	125 x 125 x 6 L					3.6	28	@	130
SP3	Reinforcing bar	N12	x		300		8.4	28	@	300

Bolts, Nuts & Washers		Material List				Cutting Schedule		
Item	Component	Section x length		Type	Quantity	No	@	Length
Bolt 1	Bolts fixing bearers to	M12	x 150	M12 x 150 cuphead	62	56	@	
Bolt 2	Bolts fixing subfloor br	M12	x 150	M12 x 150 cuphead	31	28	@	
Bolt 3		M12	x 150	M12 x 150 cuphead	0		@	
Bolt 4		M12	x 150	M12 x 150 cuphead	0		@	
Bolt 5	Bolts fixing anchorage	M12	x 150	M12 x 150 cuphead	57	52	@	
Bolt 6	Bolts fixing top chord t	M12	x 150	M12 x 150 cuphead	29	26	@	
Bolt 7	Bolts fixing bottom cho	M12	x 150	M12 x 150 cuphead	29	26	@	
Bolt 8	Bolts fixing stairs to joi	M12	x 150	M12 x 150 cuphead	2	2	@	
Wash1	Washers	M12		M12 galv flat was	210	No		
Wash2	Washers	M16		M16 galv flat was	0	No		
Scr1	10-9 x 80 T17 Class 3	4.88	x 80	Screws	200	No		
Scr2	12-11 x 50 T17 HD/TG HH Class 3 (5.59 φ			Screws	1	No		
Nail1	Jolt head nails	100	x 4.50	100 x 4.5 φ,olt he	104	kg		
Nail2	Jolt head nails	75	x 3.75	75 x 3.75 φ,olt he	104	kg		
Nail3	Jolt head nails	50	x 3.75	50 x 4.5 φ,olt hea	45	kg		
Nail4	Jolt head nails	25	x 2.50	25 x 3.75 φ,olt hea	12	kg		
Strap	Steel strap bracing	25	x 0.8	25 x 0.8 x 30 m galv	3	30m roll		90.00

Jig for Fabricating DANCER 8.4 Trusses

All members of the jig should be cut to the lengths and shapes of the production truss members (except the “short” top chord and “short” bottom chord members are not required).

The lacing and diagonal members should be fixed over and fixed to the “long” top chord and “long” bottom chord members. i.e., They should not be cut to fit between the chords.

This jig may be constructed of RHS steel (for repeated use) or timber (for a single project).

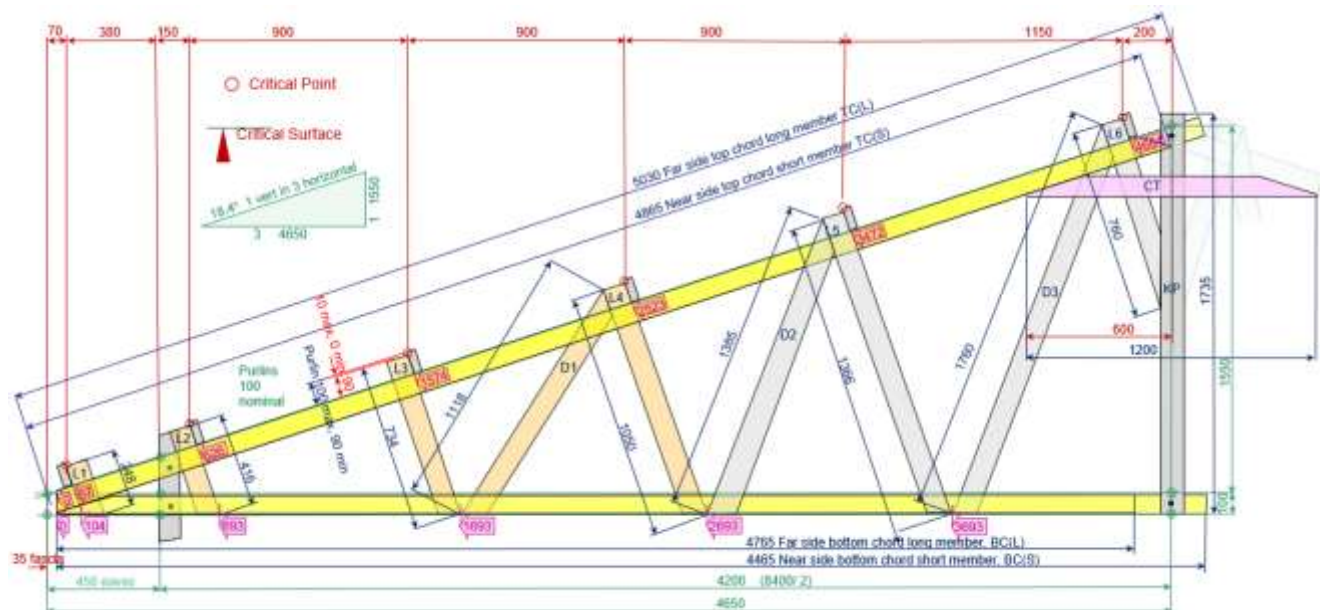

Roof Trusses					8.400
Item	Component	Section		Material	Length mm
		mm	x mm		
TC(L)	Truss Top Chord (or F	90	x 45	F7	5,030
TC(S)	Truss Top Chord (or F	90	x 45	F7	4,865
BC(L)	Truss Bottom Chord (a	90	x 45	F7	4,765
BC(S)	Truss Bottom Chord (a	90	x 45	F7	4,465
CT	Collar Tie	90	x 45	F7	1,200
KP	King Post	90	x 45	F7	1,735
L1	Lacing at eaves	90	x 45	F7	248
L2	Lacing at anchorage st	90	x 45	F7	416
L3	Lacing	90	x 45	F7	734
L4	Lacing	90	x 45	F7	1,050
L5	Lacing	90	x 45	F7	1,366
L6	Lacing	90	x 45	F7	760
D1	Diagonal	90	x 45	F7	1,118
D2	Diagonal	90	x 45	F7	1,385
D3	Diagonal	90	x 45	F7	1,762

Specifications

All construction shall comply with the comprehensive project specifications are published in a separate document. The following is a summary of some key parts of that specification.

Timber

Scope

This section covers timber framing, such as columns, posts, beams, battens, rafters, trusses and the like, consisting of sawn timber and plywood.

Relevant Standards

AS 1684.1 Residential Timber Framed Construction – Design Criteria

AS 1684.3 Residential Timber Framed Construction – Cyclonic areas

AS 1720.1 Timber structures - Part 1 Design methods

AS 1604 Timber – Preservative treated – Sawn and round

AS 2082 Visually stress-graded hardwood for structural purposes

AS 2858 Visually stress-graded softwood for structural purposes

AS 2878 Timbers – Classification into strength groups

AS 3519 Timber – Machine proof grading

Levels, Dimensions, Square and Setting Out

The structure upon which the framing is to be constructed shall be within the specified tolerances, with particular attention given to levels, dimensions, square and setting out.

Bracing

All buildings shall be adequately supported against lateral wind loads, as specified in the relevant Standard (AS 1170.2 or AS 4055). In some cases, lateral earthquake loads may be a design criterion. The bracing requirements shall be determined for the appropriate Region, Terrain Category, Topography and Shielding and recorded on the drawings by the design engineer.

Tie Down

All buildings shall be adequately tied down to resist overturning due to wind loads, as specified in the relevant Standard (AS 1170.2 or AS 4055). The tie-down requirements should be determined for the appropriate Region, Terrain Category, Topography and Shielding and recorded on the drawings by the design engineer. Ensure that all tie-down systems are continuous to the footings or to the specified location on the structure.

Timber Shrinkage

Provision shall be made for timber shrinkage. Gaps that result from timber splitting shall be repaired, filled with wood filler and sanded smooth before completion.

Preservatives

Timber in exposed applications shall be treated with pyrethroid-and metal-based light organic solvent preservatives (LOSPs) to minimize fungal decay and attack by insects.

Health Warnings and Precautions

Precautions shall be in accordance with the requirements of the relevant Regulations and, where applicable, the recommendations of the following reference *RIC Good Wood Project & the Good Wood Advisory Centre, Victoria, Preservatives*.

Light Organic Solvent Preservative (LOSP)

- LOSP is a solvent-based treatment, which inhibits fungal invasion of timber. It contains copper naphthenate, zinc naphthenate, tri-butyl tin oxide (TBTO) or pentachlorophenol (PCP), with resin or wax to improve its retention and to increase its ability to repel water.
- LOSP will release, to the atmosphere, 30-40 litres of hydrocarbon solvent per cubic metre of treated timber.
- LOSP is suitable for above-ground applications where dimensional-stability is important, is used principally in external applications (e.g., fences, decks, and outdoor furniture).
- LOSP is not suitable for in-ground applications because it does not chemically fix in the wood and will leach into the soil.
- LOSP must not be used for food storage, except where LOSP formulation is of very low toxicity.
- Where LOSP treated timber is exposed, cut or drilled, the exposed surface should be coated with a post-protection treatment.

Although previously in use, the following timber preservatives shall not be used.

- (a) *Creosote*: Creosote gives off a vapour that irritates the eyes and skin; and is therefore not recommended.
- (b) *Pigment Emulsified Creosote (PEC)*: PEC is a combination of coal tar, with a heavy metal pigment used to stabilize it. PEC is not suitable for normal building applications.
- (c) *Pentachlorophenol (PCP)*: PCP (derived from sodium pentachlorophenate) is an organochlorine family, of the same chemical group as DDT and Agent Orange. PCP can cause fatigue, fever, weight loss and nausea. PCP dioxins can also cause birth defects, allergies, or cancer. PCPs can be passed on to successive generations through sperm and breast milk. PCP must be disposed of without special technology and facilities. It is recommended that PCPs should not be used.
- (d) *Copper Chrome Arsenate (CCA)*: CCA consists of heavy metals, copper, chromium, and arsenic, which may leach from the timber and pose a health risk. CCA shall not be used; and when timber treatment is required, one of the alternatives listed above may be used.

If CCA-treated timber is already in use, the following precautions should be taken:

- Wear protective equipment when handling CCA treated timber.
 - Wash hands thoroughly after handling CCA treated timber.
 - Do not allow food to come into contact with CCA treated timber.
 - Do not burn CCA treated timber in open fires, stoves, fireplaces, or the like.
- (e) Ammoniacal copper quaternary (ACQ)
 - (f) Copper azole
 - (g) Boron

Design and Construction

Timber structures shall comply with the Drawings, Building Regulations and relevant Standard (AS 1684 [residential applications], AS 1720 [general applications]).

Minimum Strength Grade

Timber used for structural framing purposes shall have a strength grade not less than MGP10 (or F11 if applicable).

Timber Type, Properties, Preservation and Application

Timber and timber products shall comply with the Drawings, Building Regulations and relevant Standard (AS 1684 [residential applications], AS 1720 [non-residential applications]), and shall be of the nominated stress grade (or strength group), durability class, and (where appropriate) lyctid susceptibility, shrinkage and ignitability.

1. The following tables are based on AS 1684.2 & 3 Table H1. For additional properties and definitions refer to source document.
2. Preservative requirement: P = Should be preservative treated, S = Should be seasoned, O = Commonly used untreated
3. Availability: R = Readily available, L = Limited Availability
4. Durability Class: 1 = Highest natural durability to 4 = Lowest natural durability.
5. Where required to achieve particular resistance to termite and/or borer attack, the species listed herein shall be treated to achieve the hazard levels listed in AS 1684.2 & 3 Table C1.
6. Lyctid Susceptible: S = Susceptible, N = Not susceptible, R = Rarely susceptible

Timber and Timber Products for Use Below Found Level

Timber and timber products shall not be used in direct contact with the ground.

If timber is required to be embedded below ground level, it shall be painted with high-build latex paint to a height 100 mm above the concrete surface and fully encased in Grade N20 concrete (20 MPa) of sufficient thickness to provide not less than 50 mm cover to all parts of the timber.

Concrete

Scope

This section covers the construction of the following concrete members for small to medium sized buildings - Concrete footings and concrete piers.

Building Regulations and Standards

All materials and construction shall comply with the most recent version of:

- the relevant parts of the Building Regulations;
- the Standards referred to therein;
- other Standards nominated in this specification; and
- other relevant Regulations.

Relevant Standards

AS 3600 Concrete Structures

AS 3610 Formwork for concrete

AS 2870 Residential slabs and footings - Construction

AS 3799 Liquid membrane-forming curing compounds for concrete

AS/NZS 4671 Steel reinforcing materials

Definitions

Site Classifications (based on AS 2870)

Class M – Moderately reactive clay or silt sites, which can experience moderate ground movement from moisture changes

Class H – Highly reactive clay sites, which can experience high ground movement from moisture

Reinforcement

Reinforcement shall be placed in accordance with the drawings such that the following laps and cover are achieved. Three N12 corner bars 2.0-metre long shall be placed at all re-entrant corners.

Reinforcement Minimum Required Laps

Bars	500 mm
------	--------

Bar chairs shall be placed at one metre centres both ways. Bar chairs shall incorporate wide bases and be placed on metal bases that do not puncture the vapour barrier. Where fabric with 7 mm bars at 200 mm centres (SL72), or lighter, is used, the bar chair spacing shall be reduced to 800 mm. Bar chairs shall be placed to give the following clear cover.

- 40 mm in concrete in contact with unprotected ground

Placing Concrete

Trenches and footing excavations shall be dewatered and cleaned prior to concrete placement so that no softened or loosened material remains.

All concrete shall be compacted.

Reinforcement Cover - The lapping of welded fabric reinforcement in the top face of a slab will significantly increase the thickness of reinforcement and reduce the cover. The slab thickness shall be such as to provide both sufficient cover and sufficient effective depth.

Bill of Quantities

Bill of Quantities	
Project	Dei District Administration Classrooms
Partners	Vision for Homes
Use	Two classrooms + Office
Nominal plan dimensions (allowing for external cladding approx 16.5 m x 8.4 m overall, 0 verndahs, 1 external large porch under roof)	
External elevation	One habitable storey, gable roof
Internal arrangement	Two classrooms (one each end) + Office and Covered Porch between
Sub-floor, walls, roof	Steel posts, anchored timber wall & cladding, anchored timber roof
Country	Papua New Guinea
Location	Highlands
Tsunami exposure	0
Earthquake hazard, z	0.24
Cyclonic / Non-cyclonic	Non-cyclonic
Wind classification	N2
Return period	500 years
Basic wind speed	28 m/s
Road distance from nearest fabrication centre	30 km

Details

Building type	School classroom
Importance Level	2
Ground floor type	Elevated
Roof (skillion/gable/hip)	g
Roof pitch	18.4 o
Shape (R = Rectangle)	R
No of habitable storeys	1
Total length (O/A ext studs)	16.500 m
Habitable width incl porch, excl veranda	8.400 m
Total width (O/A ext studs incl covered veranda or porch)	8.400 m
Thickness of ext walls	0.090 m
Thickness of int walls	0.090 m
Habitable area (inc walls, excl veranda)	138.6 m2
Internal area habitable rooms (excl walls, excl veranda)	132.6 m2
FFL to U/S ceiling	2.500 m
Top storey height FFL to ceiling	0.000 m
Bottom storey height FFL to ceiling	2.500 m
Minimum sub-floor FFL	0.950 m
Eaves overhang (length)	0.000 m
Eaves overhang (width)	0.450 m
Is roof truss over verandas or porchs?	Yes
Plan length of roof	16.500 m
Plan width of roof	9.300 m
Is there a ceiling?	Yes
Is there eaves lining?	Yes
Bottom bolt to top bolt	0.160 m
Bottom bolt to u/s chord	0.045 m
Ceiling joist depth	0.045 m
Ceiling depth+ allowance	0.004 m
Roof rise ceiling to purlins top	1.781 m
External wall height from ground	3.450 m
Total height to ridge	5.231 m
U/S Ceiling to FFL above	0.000 m
Front veranda length under roof (incl studs)	3.300 m
Front veranda width under roof (incl studs)	2.700 m
Back veranda length under roof (incl studs)	0.000 m
Back veranda width unde roof (incl studs)	0.000 m
Rise of stairs	0.950 m
Number of external doors	1
Number of internal doors	3
Number of windows	11
Area of windows	10.56 m2
Length of internal walls	16.8 m
Roof sheeting	Steel sheet
Roof structure	Direct Anchorage Timber
External walls	Steel sheet
Internal walls	Timber frame
Footings for building	Concrete piers
Footings for steps	Concrete pad footings
Subfloor post type	Steel
Is subfloor post embedded?	Yes
Floor	Elevated timber

Site Establishment	
Item	1
Earthworks & Site Drainage	
Clear site	1
Construct site drainage	1
Excavate for concrete piers	1

Concrete

Notes

Installation

Form, place, compact & cure concrete

Concrete Piers

Number of concrete piers	28	No
Pier shape, "Square" or "Circular"	Square	
Pier depth	600	mm
Pier width (or diameter)	400	mm
Pier length (effective)	400	mm
Bearing area	4.48	m2
Post embedment or (clearance)	450	mm
Depth of concrete	600	mm
Volume of concrete per pier	0.096	m3
Wasteage	10%	
Total volume of concrete in piers	2.9568	m3
Cement in concrete	24	40 kg bags
Sand in concrete	1.48	m3
Gravel in concrete	2.96	m3
Cement in concrete	0.95	tonnes
Sand in concrete	2.22	tonnes
Gravel in concrete	5.32	tonnes
Reinforcement	N10	
Reinforcement	0.00	m
Embedded steel fittings	0	0

Steel Posts

Notes: 20

Installation

Erect steel posts			
Fabricated Steel Posts	28	28.0	No

Timber Framing										
Notes:										
<u>Installation</u>										
Construct timber framing										
<u>Materials</u>										
Timber Specification	Seasoned	F7	Softwood	Volume	0.00	m ³				
Number of trusses	13	No		Volume / Area	0.00	m ³ /m ²				
			Depth mm	Width mm	Length mm	Total m	Wasteage			
Bracing for Steel Posts	14	No	90	x 45	x 1,760	27.1	m	10%		
Solid Timber Posts	0	No	0	x 0	x 0	0.0	m	10%		
Bracing for Solid Timber Posts	0	No	0	x 0	x 0	0.0	m	10%		
Floor Bearer	35	No	140	x 45	x 3,000	115.5	m	10%		
Floor Joist	120	No	140	x 45	x 3,000	396.0	m	10%		
Floor Trimmer Joist	8	No	140	x 45	x 4,125	36.3	m	10%		
Floor Joist Blocking	0	No	0	x 0	x 0	0.0	m	10%		
Studs, Plates, Noggings	611	No	90	x 45	x 0	1,463.0	m	10%		
Roof trusses	377	No	90	x 45	x 0	858.9	m	10%		
Ceiling Joist (additional to truss bottom ch	14	No	45	x 90	x 3,000	60.7	m	44%		
Ceiling Batten	120	No	45	x 90	x 2,700	324.0	m	0%		
Veranda Rafter	0	No	90	x 45	x 0	0.0	m	10%		
Veranda Beam	0	No	140	x 45	x 1,300	0.0	m	10%		
Fascia Board	8	No	240	x 35	x 4,125	36.3	m	10%		
Barge Board	4	No	240	x 35	x 4,902	21.6	m	10%		
Roof Purlin	72	No	90	x 45	x 3,000	237.6	m	10%		
Stair Stringer	2	No	290	x 45	x 1,586	3.5	m	10%		
Stair Tread	4	No	290	x 45	x 1,820	8.0	m	10%		
Tread support	8	No	70	x 45	x 260	2.3	m	10%		
Stair stringer support	1	No	290	x 45	x 1,820	2.0	m	10%		
Stair post	6	No	90	x 45	x 975	6.4	m	10%		
Stair wales	6	No	120	x 20	x 1,586	10.5	m	10%		
Stair hand rail	2	No	120	x 20	x 1,586	3.5	m	10%		
Veranda Balustrade Post	0	No	90	x 45	x 1,120	0.0	m	10%		
Front Veranda Balustrade	2	No	120	x 20	x 2,700	5.9	m	10%		
Front Veranda Balustrade	1	No	120	x 20	x 2,400	2.6	m	10%		
Back Veranda Balustrade	0	No	120	x 20	x 0	0.0	m	10%		
Back Veranda Balustrade	0	No	120	x 20	x 0	0.0	m	10%		
Front Veranda Stinger	2	No	70	x 45	x 2,700	5.9	m	10%		
Front Veranda Stringer	1	No	70	x 45	x 2,400	2.6	m	10%		
Back Veranda Stringer	0	No	70	x 45	x 0	0.0	m	10%		
Back Veranda Stringer	0	No	70	x 45	x 0	0.0	m	10%		
Seat & Stingers	0	No	0	x 0	x 2,400	0.0	m	10%		
Seat support	0	No	0	x 0	x 420	0.0	m	10%		
Seat leg	0	No	0	x 0	x 310	0.0	m	10%		
Total timber length						3,630.2	m			
Total quantities	Total Length (including wasteage)									
70 x 45 F7	10.9	m								
90 x 45 F7	2,977.7	m								
140 x 45 F7	547.8	m								
240 x 45 F7	0.0	m								
90 x90 F7		m								
50x20F7		m								
100 x 20 F7		m								
120 x 20 F7	22.5	m								
290 x 45 F7	13.5	m								
200 x 20 F7 dressed fascia section	0.0	m								
240 x 35 F7 dressed fascia section	57.9	m								
Total timber length	3,630.2	m								
Roof Bracing	4	No	25	x 1	x 6,841	30.1	m	10%		
<u>Bolts, Nuts, Washers, Screws and Nails</u>										
<u>Bolts</u>										
Bolts fixing bearers to posts	62	No	M12 x 150 cuphead galv bolts & nuts							
Bolts fixing subfloor bracing	31	No	M12 x 150 cuphead galv bolts & nuts							
0	0	No	M12 x 150 cuphead galv bolts & nuts							
0	0	No	M12 x 150 cuphead galv bolts & nuts							
Bolts fixing anchorage studs to bearers	57	No	M12 x 150 cuphead galv bolts & nuts							
Bolts fixing top chord to anchorage studs	29	No	M12 x 150 cuphead galv bolts & nuts							
Bolts fixing bottom chords to anchorage st	29	No	M12 x 150 cuphead galv bolts & nuts							
Bolts fixing stairs to joist	2	No	M12 x 150 cuphead galv bolts & nuts							
Total number of bolts										
M12 x 150 cuphead galv bolts & nuts	210	No								
M12 x 200 cuphead galv bolts & nuts		No								
M16 x 150 cuphead galv bolts & nuts		No								
M16 x 200 cuphead galv bolts & nuts		No								
<u>Washers</u>										
Washers	210	No	M12 galv flat washers							
Washers	0	No	M16 galv flat washers							
<u>Screws</u>										
10-9 x 80 T17 Class 3 screw (4.88 φ)	200	No	Screws							
12-11 x 50 T17 HD/TG HH Class 3 (5.59	1	No	Screws							
Jolt head nails	104	kg	100 x 4.5 φ jolt head bright nails							
Jolt head nails	104	kg	75 x 3.75 φ jolt head bright nails							
Jolt head nails	45	kg	50 x 4.5 φ jolt head bright nails							
Jolt head nails	12	kg	25 x 3.75 φ jolt head galv nails							
Steel strap bracing	3		30m r25 x 0.8 x 30 m galvanised steel strap							

PGK 0

Cornice, skirting, cupboardsNotesInstallation

Instal cornice, skirting, cupboards & joiner

Cornice

19 x 19 Cornice quad	146	m
No of 3.5 m lengths \	59	No

Skirting

50 x 25 Arch skirting	146	m
No of 3.5 m lengths	59	No

Cupboards

Cupboard type	Bench, sink, 2 cupboards under
Bench, sink, 2 cupboards under	2 No

FlooringNotesInstallation

Install flooring

Materials

Nominal floor thickness	25
-------------------------	----

Internal general area

Area internal general area	125.2	m2
19mm particleboard flooring	Yes	
Area 19mm particleboard flooring	125.2	m2
19mm compressed fibre-cement sheet floor	No	
Area 15mm compressed fibre-cement sheet floor	0.0	m2
100 x 25 timber flooring	no	
Area of 100 x 25 timber flooring	0.0	m2

Internal wet area

Area external wet area	0.0	m2
19mm particleboard flooring	No	
Area 19mm particleboard flooring	0.0	m2
19mm compressed fibre-cement sheet floor	Yes	
19mm compressed fibre-cement sheet floor	0.0	m2
100 x 25 timber flooring	no	
Area of 100 x 25 timber flooring	0.0	m2

Veranda or Porch

Area veranda or porch	6.9	m2
19mm particleboard flooring	No	
Area 19mm particleboard flooring	0.0	m2
19mm compressed fibre-cement sheet floor	No	
19mm compressed fibre-cement sheet floor	0.0	m2
100 x 25 timber flooring	Yes	
Area of 100 x 25 timber flooring	6.9	m2

Total areas

19mm particleboard flooring	125.2	m2
19mm compressed fibre-cement sheet floor	0.0	m2
100 x 25 timber flooring	6.9	m2

Wasteage

19mm particleboard flooring	0.1	0
19mm compressed fibre-cement sheet floor	0.1	0
100 x 25 timber flooring	0.1	0

Total areas

19mm particleboard flooring	137.8	m2
19mm compressed fibre-cement sheet floor	0.0	m2
100 x 25 timber flooring	7.6	m2

Fixings

Flooring screws	0.0	kg
Flooring screws	0.0	kg
Flooring screws	0.0	kg

Doors

Notes

Installation

Instal doors and door furniture as listed below.

<u>Door D1</u>	External Door	
No of 2040 x 830 x 35 solid core external	3	No
Height	2040	mm
Width	820	mm
Thickness	35	mm
Material	Solid core external	
Butt hinge set (100mm, 3)	3	No
Lock set (single deadbold cylinder lock)	3	No
Closer	3	No
<u>Door D2</u>	Internal Door	
No of 2040 x 830 x 35 hollow core internal	2	No
Height	2040	mm
Width	820	mm
Thickness	35	mm
Material	ow core internal	
Butt hinge set (75mm, 3)	2	No
Lock set (single deadbold cylinder lock)	2	No
Closer	2	No

Windows

Notes

Installation

Instal windows & screens

<u>Window W1</u>	1200 x 850 louvres	
No of 1200 x 850 louvres	11	
Frame Height	1190	mm
Frame Length	842	mm
Clear opening height	1200	mm
Clear opening Lenth	855	mm
Vertical clearance	10	mm
Horizontal clearance	13	mm
Frame material	Aluminium	
Frame operation	Louvre	
Latch	Single lever	
Lock	Key lock	
Glass blade type	Clear float glass, 2 sides polished bevel	
Glass blade thickness	5	mm
Glass blade width	150	mm
Glass blade length	762	mm
Glass blade coverage	140	mm
No of blades per window	8	
Total No of blades (150 x 762, clear float	88	
No of flyscreens for 1200 x 850 louvres	11	
Width each flyscreen mesh	910	mm
Length each flyscreen mesh	1190	mm
Total lenth flyscreen mesh	13.09	m
Wastage	10%	
Order lenth flyscreen mesh	14.399	m
No security screens (4 mm wires welded	11	
Width of welded mesh sheets (4 mm wire	2000	mm
Length of welded mesh sheets (4 mm wire	3000	mm
No in width of one sheet	1	No
No in length of one sheet	2	No
No flyscreen mesh sheets	6	No

Roof Cladding

Notes:

Installation

Install roof cladding

Materials

Total area	153.5	m2	Plan area	153.5	m2	Wasteage	
Corrugated steel roof sheeting, 0.42 BMT,	123.2	m	Width	762	mm	Front half of roof	14%
Corrugated steel roof sheeting, 0.42 BMT,	123.2	m	Width	762	mm	Rear half of roof	14%
12-11 x 50 T17 HD/TG HH Class 3 (5.59 €	1,154		Top-lock hex	galv roofing screws & plastic washers			30%

Roof Sarking and Insulation

Notes:

Installation

Instal sarking & insulation

Roof Sarking

Roof sarking type	Single- sided reflective insulation	
Roof area	146.1	m2
Wasteage	10%	
Roof sarking area	160.7	m2
0	0	

Roof Blanket Insulation

Roof blanket insulation type	R1.8 reflective foil & glass fibre blanket	
Roof area	0.0	m2
Wasteage	10%	
Roof blanket insulation area	0.0	m2

Ceiling insulation type

Ceiling insulation type	R2.5 glass fibre batts or blanket	
Ceiling area	0.0	m2
Wasteage	10%	
Ceiling insulation area	0.0	

Ceiling and Wall Linings

Plywood Ceiling Lining

Plywood thickness	4	mm
Plywood sheet length	2.4	m
Plywood sheet width	1.2	m
Plywood wall area	44.6	m2
Wasteage	5%	
No of plywood sheets	17	No

Internal Wall Lining

Plywood Wall Lining		
Plywood thickness	4.0	mm
Plywood sheet length	2.400	m
Plywood sheet width	1.200	m
Plywood wall area	265.9	m2
Wasteage	5%	
No of plywood sheets	97	No

Plywood at Wet Areas

Plywood thickness	17.0	mm
Plywood sheet length	2.400	m
Plywood sheet width	1.200	m
Plywood wall area	7.74	m2
Wasteage	5%	
No of plywood sheets	5	No

Eaves

Fibre-cement Eaves Lining	Yes	
Eaves lining thickness	4.5	mm
Eaves lining sheet length	2.400	m
Eaves lining sheet width	1.200	m
Eaves lining wall length	27.75	m
Wasteage	10%	
No of fibre-cement sheets	12	No

Roof Plumbing

Notes:

Installation

Instal roof plumbing

Materials

Stock length of quad gutter	2.44	m
Stock length of rainwater downpipe	5.8	m
Finish of roof plumbing	Colorbond	
Wasteage	10%	

Specifications

Eaves gutter	Colorbond 100 quad eaves gutter
Eaves gutter stop-ends	Colorbond 100 quad stop ends
Eaves gutter brackets	Colorbond 100 quad brackets
Eaves gutter screws	12-11 x 50 T17 HD/TG HH Class 3 (5.59 φ)
Rainwater downpipes	DN80 PVC RWDP
Rainwater downpipe inlets	DN80 PVC inlet
Rainwater downpipe bends	DN80 PVC 88 bend
Rainwater downpipe brackets	Colorbond DN80 clip saddles
Rainwater downpipe bracket screws	12-11 x 50 T17 HD/TG HH Class 3 (5.59 φ)
Barge moulds	Colorbond steel 0.6 mm thick
Gable flashing	Colorbond steel 0.6 mm thick
Flashing & barge fixings	Galv roofing nails 65 x 3.75mm x 500g
Flashing & barge fixings	Jolt head nails 125 x 5.6mm x 500g

Quantities before wasteage

Eaves gutter	33	m
Eaves gutter stop-ends	4	No
Eaves gutter brackets	55	No
Eaves gutter screws	220	No
RWDPs (Rainwater downpipes)	0.0	m
RWDP inlets	0	No
RWDP bends	0	No
RWDP brackets	0	No
RWDP bracket screws	0	No
Ridge flashing	16.5	m
Barge moulds	19.6	m
Flashing & barge fixings	10	kg
Flashing & barge fixings	2.5	kg

Quantities to order

Colorbond 100 quad eaves gutter	34.2	m	Eaves gutter
Colorbond 100 quad stop ends	4	No	Eaves gutter stop-ends
Colorbond 100 quad brackets	61	No	Eaves gutter brackets
12-11 x 50 T17 HD/TG HH Class 3 (5.59 φ)	242	No	Eaves gutter screws
DN80 PVC RWDP	0.0	m	RWDPs (Rainwater downpipes)
DN80 PVC inlet	0	No	RWDP inlets
DN80 PVC 88 bend	0	No	RWDP bends
Colorbond DN80 clip saddles	0	No	RWDP brackets
12-11 x 50 T17 HD/TG HH Class 3 (5.59 φ)	0	No	RWDP bracket screws
Colorbond steel 0.6 mm thick	19.0	m	Ridge flashing
Colorbond steel 0.6 mm thick	22.0	m	Barge moulds
Galv roofing nails 65 x 3.75mm x 500g	11	kg	Flashing & barge fixings
Jolt head nails 125 x 5.6mm x 500g	3	kg	Flashing & barge fixings

External Wall Cladding

Notes

Installation

Install external wall cladding

Cladding

90 x 20 F7 timber weather boards	24.7	m2
0.40mm BMT zinalume steel sheet (6 No	170.3	m2
0.35mm BMT zinalume steel sheet (10 N	0.0	m2

Fixings

10-9 x 80 T17 Class 3 screw (4.88 ϕ)	224	No
12-11 x 50 T17 HD/TG HH Class 3 (5.59 c	1548	No

Ceiling and Wall Linings

Notes

Installation

Install ceiling lining
Install wall lining
Install eaves lining

Ceiling Lining

Plywood Ceiling Lining

Plywood thickness	4.0	mm
Plywood sheet length	2.400	m
Plywood sheet width	1.200	m
Plywood wall area	134.2	m2
Wasteage	5%	
No of plywood sheets	49	No

Plasterboard Ceiling Lining

Plasterboard thickness	10	mm
Plasterboard sheet length	2.4	m
Plasterboard sheet width	1.2	m
Plasterboard wall area	0	m2
Wasteage	0.05	0
No of plasterboard sheets	0	No

Ceiling Fixings & Consumables

Ceiling fixings	0	0
Ceiling consumables	0	0
Ceiling consumables	0	0

Internal Wall Lining

Plywood Wall Lining		
Plywood thickness	4.0	mm
Plywood sheet length	2.400	m
Plywood sheet width	1.200	m
Plywood wall area	364.3	m2
Wasteage	10%	
No of plywood sheets	140	No

Plywood at Wet Areas

Plywood thickness	17.0	mm
Plywood sheet length	2.400	m
Plywood sheet width	1.200	m
Plywood wall area	0	m2
Wasteage	10%	
No of plywood sheets	0	No

Plasterboard Wall Lining

Plasterboard thickness	10.0	mm
Plasterboard sheet length	2.400	m
Plasterboard sheet width	1.200	m
Plasterboard wall area	0.0	m2
Wasteage	10%	0
No of plasterboard sheets	0	No

Internal Wall Fixings & Consumables

Wall fixings	0	0
Wall consumables	0	0

Eaves & Veranda Ceiling

Fibre-cement Eaves & Veranda Ceiling	Yes	
Eaves & veranda ceiling thickness	4.5	mm
Eaves & veranda ceiling sheet length	2.400	m
Eaves & veranda ceiling sheet width	1.200	m
Eaves & veranda ceiling required length of	24.75	m
Wasteage	10%	
No of fibre-cement sheets	11	No

Eaves & Veranda Ceiling Fixings & Consumables

Eaves & veranda ceiling fixings	0	0
Eaves & veranda ceiling consumables	0	0
Eaves & veranda ceiling consumables	0	0
Tie wire	10	kg
2	0	0

Painting

Notes:

Installation

Paint all exposed surfaces where specified

Required primer volume

External walls (timber)	0.0	litres	Latex wood primer	10A
External barge, fascia, gables (timber)	4.0	litres	Latex wood primer	10A
External eaves (timber, fibre-cement)	4.0	litres	Latex wood primer	10A
External doors & other (timber)	4.0	litres	Latex wood primer	10A
External metalwork (steel)	4.0	litres	Metal primer for zinc-coated surfaces	11
Internal walls (plywood, plasterboard)	8.0	litres	Latex plasterboard sealer	16
Internal ceilings (plywood, plasterboard)	4.0	litres	Latex plasterboard sealer	16
Internal doors (timber)	4.0	litres	Latex plasterboard sealer	16
Internal windows & other (timber)	4.0	litres	Latex plasterboard sealer	16
Internal metalwork (steel, aluminium)	4.0	litres	Metal primer for zinc-coated surfaces	11

Required top-coat volume

External walls (timber)	0.0	litres	Semi-gloss washable exterior latex	8
External barge, fascia, gables (timber)	4.0	litres	Semi-gloss washable exterior latex	8
External eaves (timber, fibre-cement)	4.0	litres	Semi-gloss washable exterior latex	8
External doors & other (timber)	4.0	litres	Gloss washable exterior latex	9
External metalwork (steel)	4.0	litres	Gloss washable exterior latex	9
Internal walls (plywood, plasterboard)	24.0	litres	Semi-gloss mould resistant latex	8
Internal ceilings (plywood, plasterboard)	12.0	litres	Semi-gloss mould resistant latex	8
Internal doors (timber)	4.0	litres	Solvent-borne gloss interior	9
Internal windows & other (timber)	4.0	litres	Solvent-borne gloss interior	9
Internal metalwork (steel, aluminium)	4.0	litres	Solvent-borne gloss interior	9

Painting Consumables

Paint roller tray kit	2	No
Paint brushes (100 mm)	3	No
Paint brushes (75 mm)	3	No
Paint brushes (50 mm)	3	No
Paint brushes (38 mm)	3	No
Turps (4 litres)	2	No

Electrical Installation

Note: Inclusion of electrical installation is subject to instruction by the client.

Installation

Install electrical system
Connect to electrical mains

Building Wiring

Meter box	1	No	Meter box 300 x 300 x 250 mm
Load centre	1	No	PVC 6 Pole Load Centre (PVC Modern)
Circuit breaker 63 A (Main)	1	No	Circuit Breaker Single Pole 63A Tesla MCB1P63
Circuit breaker 16 A (Power)	8	No	Circuit Breaker Single Pole 16A (Power) MCB16
Circuit breaker 10 A (Light)	1	No	Circuit Breaker 1 Pole 10A (Light) MCB10
Cable (mains) 10 mm	20	m	Cable Mains Twin & Earth 10 mm
Cable (GPOs) 2.5 mm	70	m	Cable Twin & Earth 2.5 mm
Cable(Lights) 1.5 mm	100	m	Cable Twin+ECC 1.5 mm TPS 'DN 100mt
Cable (Twin active TPS 1.5. PR LM)	0	m	Cable Twin Active TPS 1.5 mm PR LM
Cable (Earthwire [green & yellow])	20	m	Earthwire Yellow& Green Stripe
Single GPO outlets	0	No	Single GPO 10A 250V ED(EDWGPO1)
Double GPO outlets	16	No	Double GPO2 10A Tesla
0	0	No	Switch single power point 10A AS 314
External weatherproof switch	1	No	Weatherproof 10A 2 Gang Surf/Switch
Internal light switch	8	No	Wall light switch 2 Gang (AS314)
Security light switch	0	No	Switch Eye Day Light 10A (Natec)
Lights (1 x 18W, 613 x 26mm bare batten	8	No	Lights Fittings 1 x 18 Watt (Davis LPB118)
Lights (1 x 36W, 1222 x 26mm bare batte	0	No	Lights Fittings 1 x 36 Watt (Davis LPB136)
Lights (2 x 18W, 613 x 26mm bare batten	0	No	
Lights (2 x 36W, 1222 x 26mm bare batte	0	No	
Solar Lights (1 x 18W, 613 x 26mm bare t	0	No	
Lights	0	No	
Lights	0	No	
Stud brackets	17.5	No	DN Stud Brackets Vertical & Horizontal
Wire connectors	26.25	No	Connectors Single Screw Loose
Hex head screws (10-16x 16 mm)	223.125	No	Hex head screws (10-16x 16 mm)
Insulation tape	2	No	PVC Electrical Insulation Tape 18mmx 20m Red
Mains Supply			
J Hook	1	No	Mains Entry Box 2 way single phase
Dead ends	2	No	Dead ends with rubber 10-16mm DIS 80610
Copper earth stake	1	No	Copper earth stake 13mmx1.4 m E/CLIP

Plumbing

External Taps

External taps	1	No	
Compression unions	1	No	
Compression elbows	1	No	
Compression tees	1	No	

Cold Water Copper Pipe

Copper pipe specification	DN15 copper tube		
Brass fittings specification	DN15 brass fittings		
Wasteage	10%		
Copper pipe length (DN15)	18.7	m	
Brass FF unions (DN15)	5	No	
Brass FF elbows (DN15)	5	No	
Brass FFF tees (DN15)	5	No	

Rainwater and Header Tanks

Notes:

Installation

Instal rainwater tank, header tank, pipewo

Materials

Rainwater tank specification	Polyethylene rainwater tank	
Rainwater tank volume	5500	litres
Number of rainwater tanks	2	No
Header tank specification	Polyethylene header tank with roof support	
Header tank volume	200	litres
Number of header tanks	1	No
Electric pump specification	Centrifugal 1400 W, 240 V electric pump and contoller	
Electric pump capacity	60	l/m
Number of electric pumps	0	No
Hand pump specification	Mini rotary hand pump	
Hand pump capacity	30	l/m
Number of hand pumps	1	No

Rainwater uPVC Pipe (roof gutter to tank)

uPVC pipe specification	DN80 uPVC pipe	
uPVC fittings specification	DN80 uPVC fittings	
Wasteage	10%	
uPVC pipe length	15.2	m
uPVC FF unions	0	No
uPVC FF elbows	4	No
uPVC FFF tees	0	No
uPVC gutter inlet	4	No
Other fittings	0	No

Rainwater HDPE Pipe (tanks & pump to h

Pipe specification	DN32 HDPE pipe	
Fittings specification	DN32 HDPE & brass fittings	
Wasteage	10%	
Pipe length (DN32 HDPE pipe)	14.6	m
Unions (DN32 HDPE pipe)	6	No
Elbows (DN32 HDPE pipe)	7	No
Tees (DN32 HDPE pipe)	0	No
Valves (brass FF gate valves)	3	No
Other fittings	0	No

Rainwater Copper Pipe (into building)

Copper pipe specification	DN15 copper pipe	
Brass fittings specification	DN15 brass fittings	
Wasteage	10%	
Pipe length	8.4	m
Brass FF unions	5	No
Brass FF elbows	5	No
Brass FFF tees	5	No
Other brass fittings	0	No
Other fittings	0	No

Rainwater Plumbing Consumables

PTFE Tape Seal	2	No
Nylon compression olives (15mm)	5	Packs

Window Shades

Window shades are subject to client instru

Installation

Install window shades.

Window Shades

Number of window shades	4	No
Wall system	Steel sheet	
Window frame length	842	mm
Opening length	855	mm
Overall length	991	mm
Covered width (protruding from studs/mas	800	mm
Eaves (beyond covered width)	0	mm
Total width (protruding from studs/masonr	800	mm
Slope	18.4	o

Gable cladding

Gable cladding type	90 x 19 Weatherboard	
Gable cladding area each shade	0.38	m2
Wasteage	10%	
Gable cladding total area	1.66	m2

Roof sheeting

Roof sheeting type	0.42 BMT steel colorbond corrugated roof sheeting	
Coverage width	762	mm
Roof sheeting area each shade	0.84	m2
Wasteage	30%	
Roof sheeting total area	4.35	m2
Length of sheet required	5.703	m

Gutter

Gutter type	0	
Gutter length each shade	0	m
Wasteage	10%	
Gutter total length	0	m

<u>Downpipe</u>	0	
Downpipe type	0	
Downpipe length each shade	0	m
Wasteage	10%	
Downpipe total length	0	m
<u>Wall / roof flashing</u>	0	
Wall /roof flashing type	200 x 0.5 colorbond	
Wall /roof flashing length each shade	0.991	m
Wasteage	10%	
Wall /roof flashing total length	4.36	m
<u>Barge flashing</u>	0	
Barge flashing type	200 x 0.5 colorbond	
Barge flashing length each shade	1.687	m
Wasteage	10%	
Barge flashing total length	7.42	m
<u>Timber framing</u>	0	
Top chord, bottom chord, purlins	90 x 45 F7	
Vertical members	90 x 45 F7	
Vertical near wall	90 x 90 F7	
Posts	90 x 90 F7	
<u>Cutting List</u>		
Top chord	2	No
90 x 45 F7	938	mm
Bottom chord	2	No
90 x 45 F7	890	mm
Purlins	3	No
90 x 45 F7	901	mm
Vertical furthest from wall	2	No
90 x 45 F7	251	mm
Intermediate vertical	0	No
90 x 45 F7	0	mm
Vertical near wall	2	No
90 x 90 F7	370	mm
Post	0	No
90 x 90 F7	0	mm
<u>BOQ</u>		
Wasteage	10%	
90 x 45 F7	30.2	m
140 x 45 F7	0.0	m
90 x 90 F7	3.3	m
<u>Timber Screws</u>	0	
Timber screw size	10-9 x 80 T17 Class 3 screw (4.88 ϕ)	
No of timber screws each shade	56	No
Wasteage	10%	
Total No of timber screws	246	No
<u>Bolts</u>	0	
Bolt size	M12 x 200 galv cuphead bolts, nuts & washers	
No bolts each shade	4	No
Wasteage	10%	
Total No bolts & nuts	18	No
Total No washers	18	No
<u>Roofing Screws</u>	0	
Roofing screw type	12-11 x 50 T17 HD/TG HH Class 3 (5.59 ϕ)	
Cladding screws	66	No
Wasteage	30%	0
Total number of roofing screw	86	No
<u>Flashing Screws</u>	0	
Flashing screw size	12-11 x 50 T17 HD/TG HH Class 3 (5.59 ϕ)	
No of flashing screws each shade	26	No
Wasteage	10%	0
Total No flashing screws	114	No

Calculations

Refer to the Excel Workbook “DANCER Building Design 220614”, retained in the following directory –
 C:\Users\rod\Documents\0Q QMS-PHA\220406 PHA VFH-PNG Kenembo-Runimb 2 Classrooms & Office
 A screen shot of the cover page is shown below.

 Quasar Management Services Pty Limited ABN 21 003 954 210 Member of Consult Australia Not-for-profit consulting structural and civil engineer. A subsidiary of Partner Housing Australasia (Building) Incorporated 272 Blackwall Road, Woy Woy NSW 2256, Australia Phone: +61 432 611 550 Email: rod@electronicblueprint.com.au		
Building Design & Construction		
Designation		
Project	P	P
Partner Organisation	V	
Coordination	P	
Design	Q	
Design Check	Q	
Builder	V	
Site Inspection	Q	
Use	S	S
Length, width, (habitable width), verandas,porche	16.5 x 8.4 (8.4), 0, 1	16.5 x 8.4 (8.4), 0, 1
No of storeys, roof type	1, g	
No of private rooms, window width	3, 800	3, 800
Sub-floor, walls, roof frame	s, t, t	
Summary		
Project	Dei District Administration Classrooms	Dei District Administration Classrooms
Partners	Vision for Homes	
Use	Two classrooms + Office	Two classrooms + Office
Nominal plan dimensions (allowing for external cladding approximately 20 mm)	16.5 m x 8.4 m overall, 0 verndahs, 1 external large porch under roof	16.5 m x 8.4 m overall, 0 verndahs, 1 external large porch under roof
External elevation	One habitable storey, gable roof	
Internal arrangement	Two classrooms (one each end) + Office and Covered Porch between	Two classrooms (one each end) + Office and Covered Porch between
Sub-floor, walls, roof	Steel posts, anchored timber wall & cladding, anchored timber roof	
Country	Papua New Guinea	
Location	Highlands	
Tsunami exposure	0.00	
Earthquake hazard, z	0.24	
Cyclonic / Non-cyclonic	Non-cyclonic	
Wind classification	N2	N2
Return period	500	
Region	Highlands	
Basic wind speed	28.0	
Basic wind speed	28.0	
Basic wind speed error?	OK	
Road distance from nearest fabrication centre	30 km	

Building Parameters		
Building type	School classroom	
Importance Level	2	
Ground floor type	Elevated	
Roof (skillion/gable/hip)	g	
Roof pitch	18.43 °	
Shape (R = Rectangle)	R	
No of habitable storeys	1	
Total length (O/A ext studs)	16.500 m	16.500
Habitable width incl porch, excl veranda	8.400 m	8.400
Total width (O/A ext studs incl covered veranda on	8.400 m	8.400
Thickness of ext walls	0.090 m	
Thickness of int walls	0.090 m	
Habitable area (inc walls, excl veranda)	138.6 m ²	
Internal area habitable rooms (excl walls, excl ver	132.6 m ²	
FFL to U/S ceiling	2.500 m	
Top storey height FFL to ceiling	0.000 m	
Bottom storey height FFL to ceiling	2.500 m	
Minimum sub-floor FFL	0.950 m	
Eaves overhang (length)	0.000 m	
Eaves overhang (width)	0.450 m	
Is roof truss over verandas or porchs?	Yes	
Plan length of roof	16.500 m	
Plan width of roof	9.300 m	
Is there a ceiling?	Yes	
Is there eaves lining?	Yes	
Bottom bolt to top bolt	0.160 m	
Bottom bolt to u/s chord	0.045 m	
Ceiling joist depth	0.045 m	
Ceiling depth+ allowance	0.004 m	
Roof rise ceiling to purlins top	1.781 m	
External wall height from ground	3.450 m	
Total height to ridge	5.231 m	
U/S Ceiling to FFL above	0.000 m	
Front veranda length under roof (incl studs)	3.300 m	3.300
Front veranda width under roof (incl studs)	2.700 m	2.700
Back veranda length under roof (incl studs)	0.000 m	0.000
Back veranda width unde roof (incl studs)	0.000 m	
Rise of stairs	0.950 m	
Number of external doors	1	
Number of internal doors	3	3
Number of windows	11	11
Area of windows	10.56 m ²	
Length of internal walls	16.8 m	16.8
Roof sheeting	Steel sheet	
Roof structure	Direct Anchorage Timber	
External walls	Steel sheet	
Internal walls	Timber frame	
Footings for building	Concrete piers	
Footings for steps	Concrete pad footings	
Subfloor post type	Steel	
Is subfloor post embedded?	Yes	
Lines of posts supporting bearers	4	
Lines of bearers supporting joists	7	
Posts under roof	28	
Additional veranda posts (not under roof)	0	
Total number of posts	28	
Transverse post spacing	2,700 mm	
Longitudinal post spacing	2,700 mm	
Floor	Elevated timber	
Is veranda seat required?	No	
Is veranda beam required?	No	

Structural Design Parameters	
Foundations	
Foundations	Moderate clay
Site classification (A, S, M, H, P)	M
Characteristic compacted density	20 kN/m ³
Characteristic internal friction angle	27 °
Characteristic cohesion	6 kPa
Characteristic external friction angle (rough surface)	35 °
Is pier "Square" or "Circular"	Square
Nominal footing width	0.45 m
Effective footing width	0.45 m
Nominal footing depth	0.60 m
N _q	13.20 -
N _c	23.94 -
N _q	14.47 -
Z _q	1.00 -
Z _{qi}	1.00 -
Z _{qt}	1.00 -
Z _c	1.00 -
Z _{ci}	1.00 -
Z _{ct}	1.00 -
Z _q	1.00 -
Z _{qi}	1.00 -
Z _{qt}	1.00 -
Ultimate bearing capacity	816 kPa
Capacity reduction factor to working stress	0.33 -
Working bearing capacity	272 kPa
Skin friction resisting uplift	4.5 kN/pier
Tsunami	
Distance from high water mark	500 km
Height of finished floor above mean sea level	800 m
Distance from high earthquake area (Z > 0.4)	100 km
Site specific exposure	1.0
Tsunami risk factor	0.00
Flooding	
Distance to closest water course	300 m
Height of finished floor above normal level of water	3.0 m
Catchment area	30 km ²
Concentration of catchment runoff past structure	1.0
Flash flooding risk factor	0.00
Earthquake	
Use	Two classrooms + Office
Importance level	2
Hazard factor	0.24
Subsoil classification	Ce
Wind	
Use	Two classrooms + Office
Country	Papua New Guinea
Location	Highlands
Cyclonic or non-cyclonic ?	Non-cyclonic
Cardinal direction	Any direction
Terrain category	2.0
Shielding (NS, PS, FS)	PS
Topographic classification	T0
Region	Highlands
Wind classification (AS4055)	N1
Roof general wind uplift	0.47 kPa
Wall general wind suctions	0.29 kPa
Snow	
Location	Papua New Guinea
Hazard factor	No snow

Refer to the workbook for all calculations